

JVC

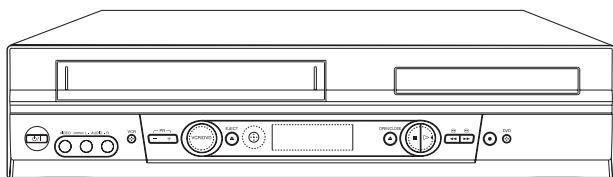

DVD PLAYER/VIDEO CASSETTE RECORDER

HR-XV2EK



DVD
VIDEO™

VHS
PAL

COMPACT
disc
DIGITAL VIDEO

COMPACT
disc
DIGITAL AUDIO

MP3

ds
DIGITAL OUT

DD DOLBY
DIGITAL

3D Surround
Sound

Plays
Windows
Media™

VIDEOplus+



OWNER'S MANUAL

P/N : 3834RP0093F

LPT0822-001A

Safety Precautions / Important



WARNING
RISK OF ELECTRIC SHOCK
DO NOT OPEN



WARNING: TO REDUCE THE RISK OF ELECTRIC SHOCK DO NOT REMOVE COVER (OR BACK) NO USER-SERVICEABLE PARTS INSIDE REFER SERVICING TO QUALIFIED SERVICE PERSONNEL.



This lightning flash with arrowhead symbol within an equilateral triangle is intended to alert the user to the presence of uninsulated dangerous voltage within the product's enclosure that may be of sufficient magnitude to constitute a risk of electric shock to persons.



The exclamation mark within an equilateral triangle is intended to alert the user to the presence of important operating and maintenance (servicing) instructions in the literature accompanying the product.

WARNING: TO REDUCE THE RISK OF FIRE OR ELECTRIC SHOCK, DO NOT EXPOSE THIS PRODUCT TO RAIN OR MOISTURE.

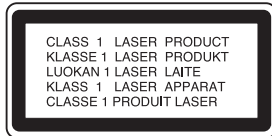

CAUTION:

This Digital Video Disc Player employs a Laser System.

To ensure proper use of this product, please read this owner's manual carefully and retain for future reference, should the unit require maintenance, contact an authorized service location—see service procedure.

Use of controls, adjustments or the performance of procedures other than those specified herein may result in hazardous radiation exposure.

To prevent direct exposure to laser beam, do not try to open the enclosure. Visible laser radiation when open. **DO NOT STARE INTO BEAM.**

CAUTION: The apparatus shall not be exposed to water, dripping or splashing and that no objects filled with liquids, such as vases, shall be placed on the apparatus.



This product is manufactured to comply with the radio interference requirements of EEC DIRECTIVE 89/336/EEC, 93/68/EEC and 73/23/EEC.

Notes on copyrights:

It is forbidden by law to copy, broadcast, show, broadcast via cable, play in public, or rent copyright material without permission.

This product features the copy protection function developed by Macrovision. Copy protection signals are recorded on some discs.

This product incorporates copyright protection technology that is protected by method claims of certain U.S. patents and other intellectual property rights owned by Macrovision Corporation and other rights owners. Use of this copyright protection technology must be authorized by Macrovision Corporation, and is intended for home and other limited viewing uses only unless otherwise authorized by Macrovision Corporation. Reverse engineering or disassembly is prohibited.

SERIAL NUMBER: The serial number is found on the back of this unit. This number is unique to this unit and not available to others. You should record requested information here and retain this guide as a permanent record of your purchase.

Model No. _____

Serial No. _____

Features:

- Complete versatility to play DVD, VCDs, audio CDs or VHS Tapes.
- Watch a DVD while recording a TV show to the VCR.
- Remote controls DVD, VCR decks and JVC TV.
- Records from DVD to VHS (unless DVD is copy protected with Macrovision).
- Hi-Fi Stereo VCR.

Important

Connection to the mains supply in the United Kingdom. DO NOT cut off the mains plug from this equipment.

If the plug fitted is not suitable for the power points in your home or the cable is too short to reach a power point, then obtain a proper safety approved extension lead/adaptor or consult your dealer.

In the unlikely event of the plug fuse failing be sure to replace the fuse only with an identical approved type, as originally fitted, and to replace the fuse cover. If the fuse fails again consult your nearest JVC dealer.

If nonetheless the mains plug is cut off remove the fuse and dispose of the plug immediately, to avoid a possible shock hazard by inadvertent connection to the mains supply.

If this product is not supplied fitted with a mains plug then follow the instructions given below :

DO NOT make any connection to the Larger Terminal coded E or Green. The wires in the mains lead are coloured in accordance with the following code :

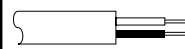

Blue to N (Neutral) or Black
Brown to L (Live) or Red

If these colours do not correspond with the terminal identifications of your plug, connect as follows :

Blue wire to terminal coded N (Neutral) or coloured Black.
Brown wire to terminal coded L (Live) or coloured Red.

If in doubt — consult a competent electrician.

Introduction

Safety Precautions	2
Important	2
Table of Contents	3
Before Use	4-5
Playable Discs	4
Precautions	5
Notes on Discs	5
About Symbols	5
Front Panel and Display Window	6
Remote Control	7
Remote A/B/C/D Code Switching	8
TV Multi-Brand Remote Control	9
Rear Panel	10

Preparation

Connections	11-12
Connecting to a TV (Satellite or Set Top Box)	11
Connecting to Optional Equipment	12
Important notes on controlling this unit.	12
Before Operation - VCR part	13-17
Tuning in a video channel on your TV	13
Initial preset	13
Setting the clock Manually	14
To set the colour system	14
How to using the main menu	15
Tuning in TV stations Automatically	15
Tuning in TV stations Manually	16
Changing the other of TV stations	17
Deleting TV stations	17
Before Operation - DVD part	18-21
General Explanation	18
On-Screen Display	18
Initial Settings	19-21
• Initial Settings General Operation	19
• Language	19
• Picture	19
• Sound	20
• Others (DRC/Vocal/PBC)	20
• Parental Control	21

Operation



Operation with Tape	22-25
Playing a tape	22
• CM (Commercial Message) Skip	22
• EPC (Easy Picture Control)	22
Instant Timer Recording (ITR)	23
VIDEO Plus+ Recording	24
Timer recording using On Screen Display	25
Operation with DVD and Video CD	26-28
Playing a DVD and Video CD	26
General Features	26
• Moving to another TITLE	26
• Moving to another CHAPTER/TRACK	26
• Slow Motion	26
• Still Picture and Frame-by-Frame Playback	27
• Search	27
• Random	27
• Repeat	27
• Repeat A-B	27
• Time Search	27
• 3D Surround	27
• Zoom	28
• Marker Search	28
Special DVD Features	28
• Title Menu	28
• Disc Menu	28

• Camera Angle	28
• Changing the Audio Language	28
• Subtitles	28
Operation with Audio CD and MP3/WMA Disc. 29-30	
Playing an Audio CD and MP3/WMA Disc	29
• Notes on MP3/WMA Recordings	30
• Pause	30
• Moving to another Track	30
• Repeat Track/All/Off	30
• Search	30
• Random	30
• Repeat A-B	30
• 3D Surround	30
• Changing the Audio Channel	30
Operation with JPEG Disc. 31	
Viewing a JPEG disc	31
• Moving to another file	31
• Repeat All/Off	31
• Notes on JPEG Recordings	31
Programmed Playback	32
Programmed Playback with Audio CD and MP3/WMA/JPEG Disc	32
Programmed Playback with Video CD	32
• Repeat Programmed Tracks/All/Off	32
• Repeat Programmed All/Off	32
• Erasing a Track/JPEG from Program list	32
• Erasing the Complete Program list	32
Additional Operation - VCR part	33-34
On Screen Display	33
Tape Counter Memory Stop	33
Child Lock	33
Hi-Fi Stereo Sound System	34
Wide Screen Compatibility 16:9	34
To set the decoder	34
Additional Operation - DVD part	35
Last Condition Memory	35
Screen Saver	35
Video Mode Setting	35
Special Recording	36
Copying from DVD to VCR	36
Recording from another video recorder	36

Reference



Troubleshooting	37
Language Code List	38
Country Code list	39
Specification	40

About the symbols for instructions

-  Indicates hazards likely to cause harm to the unit itself or other material damage.
-  Indicates special operating features of this unit.
-  Indicates tips and hints for making the task easier.

Before Use

Playable Discs

	DVD (8 cm / 12 cm disc)
	Video CD (VCD) (8 cm / 12 cm disc)
	Audio CD (8 cm / 12 cm disc)

In addition, this unit can play a CD-R or CD-RW that contains audio titles or MP3, WMA or JPEG files and SVCD also.

Notes

- Depending on the conditions of the recording equipment or the CD-R/RW disc itself, some CD-R/RW discs cannot be played on the unit.
- The unit cannot play the CD-R/RW discs that contain no data, or contain different kinds of formatted data other than MP3 and CD-DA data.
- Do not attach any seal or label to either side (the labeled side or the recorded side) of a disc.
- Do not use irregular shaped CDs (e.g., heart-shaped or octagonal). It may result in malfunctions.

Notes on DVDs and Video CDs

Some playback operations of DVDs and Video CDs may be intentionally fixed by software manufacturers. As this unit plays DVDs and Video CDs according to disc content designed by the software manufacturer, some playback features of the unit may not be available, or other functions may be added.

Refer also to the instructions applied with the DVDs and Video CDs. Some DVDs made for business purposes may not be played on the unit.

Regional code of the DVD player and DVDs

This DVD player is designed and manufactured for playback of region “2” encoded DVD software. The region code on the labels of some DVD discs indicates which type of player can play those discs. This unit can play only DVD discs labeled “2” or “ALL”. If you try to play any other discs, the message “Check Regional Code” will appear on the TV screen. Some DVD discs may not have a region code label even though their playback is prohibited by area limits.



Disc-related terms

Title (DVD only)

The main film content or accompanying feature content or additional feature content, or music album. Each title is assigned a title reference number enabling you to locate it easily.

Chapter (DVD only)

Sections of a picture or a musical piece that are smaller than titles.

A title is composed of one or several chapters. Each chapter is assigned a chapter number, enable you to locate the chapter you want. Depending on the disc, no chapters may be recorded.

Track (Video CD and audio CD only)

Sections of a picture or a musical piece on a video CD or an audio CD. Each track is assigned a track number, enabling you to locate the track you want.

Scene

On a video CD with PBC (Playback control) functions, moving pictures and still pictures are divided into sections called “Scenes”. Each scene is displayed in the menu screen and assigned a scene number, enabling you to locate the scene you want.

A scene is composed of one or several tracks.

Types of video CDs

There are two types of video CDs:

Video CDs equipped with PBC (Version 2.0)

PBC (Playback control) functions allow you to interact with the system via menus, search functions, or other typical computer-like operations. Moreover, still pictures of high resolution can be played if they are included in the disc.

Video CDs not equipped with PBC (Version 1.1)

Operated in the same way as audio CDs, these discs allow playback of video pictures as well as sound, but they are not equipped with PBC.

Before Use (Cont'd)

Precautions

Handling the unit

When shipping the unit

The original shipping carton and packing materials come in handy. For maximum protection, re-pack the unit as it was originally packed at the factory.

When setting the unit

The picture and sound of a nearby TV or radio may be distorted during playback. In this case, position the unit away from the TV or radio, or turn off the unit after removing the disc.

To keep the surface clean

Do not use volatile liquids, such as insecticide spray, near the unit. Do not leave rubber or plastic products in contact with the unit for a long period of time. They will leave marks on the surface.

Cleaning the unit

To clean the cabinet

Use a soft, dry cloth. If the surfaces are extremely dirty, use a soft cloth lightly moistened with a mild detergent solution. Do not use strong solvents, such as alcohol, benzene, or thinner, as these might damage the surface of the unit.

To obtain a clear picture

The DVD player is a high-tech, precision device. If the optical pick-up lens and disc drive parts are dirty or worn down, the picture quality will be poor. Regular inspection and maintenance are recommended after every 1,000 hours of use. (This depends on the operating environment.)
For details, please contact your nearest dealer.

Notes on Discs

Handling discs

Do not touch the playback side of the disc. Hold the disc by the edges so that fingerprints will not get on the surface.
Do not stick paper or tape on the disc.



Storing discs

After playing, store the disc in its case. Do not expose the disc to direct sunlight or sources of heat, or leave it in a parked car exposed to direct sunlight, as there may be a considerable temperature increase inside the car.

Cleaning discs

Fingerprints and dust on the disc can cause poor picture quality and sound distortion. Before playing, clean the disc with a clean cloth. Wipe the disc from the center out.

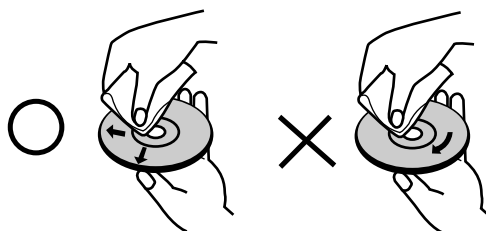

Do not use strong solvents such as alcohol, benzene, thinner, commercially available cleaners, or anti-static spray intended for older vinyl records.







About Symbols

About the symbol display

“” may appear on the TV screen during operation. This icon means the function explained in this owner's manual is not available on that specific DVD video disc.

About the disc symbols for instructions

A section whose title has one of the following symbol is applicable only to the disc represented by the symbol.

-  DVD
-  Video CDs with the PBC (playback control) function.
-  Video CDs without the PBC (playback control) function.
-  Audio CDs.
-  MP3 disc.
-  WMA disc.
-  JPEG disc.

Front Panel and Display Window

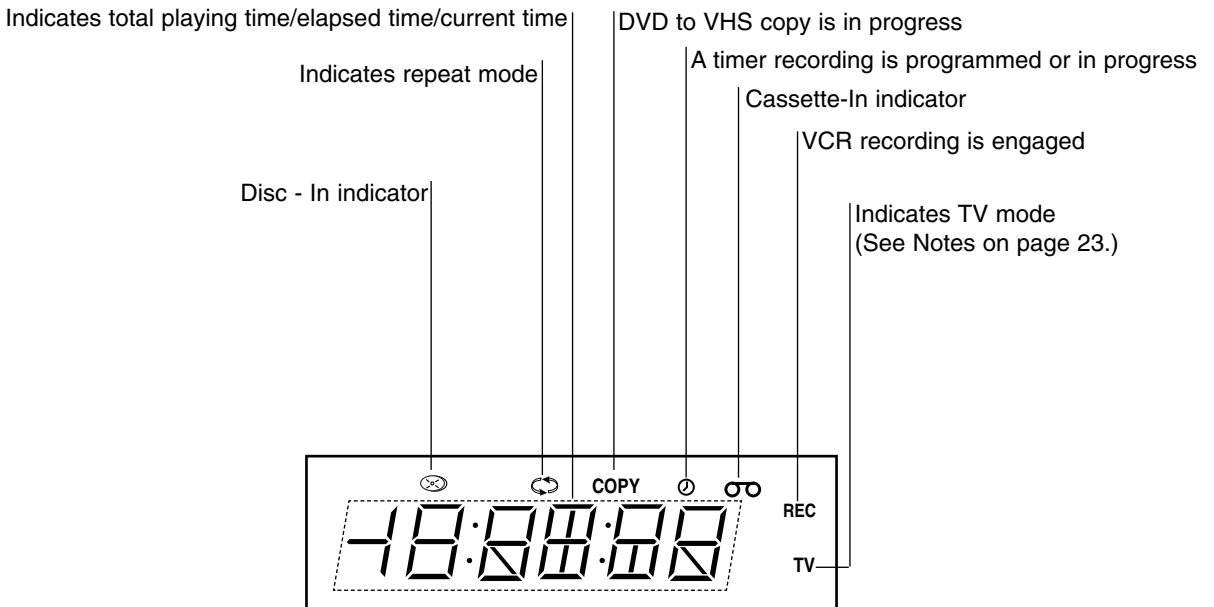
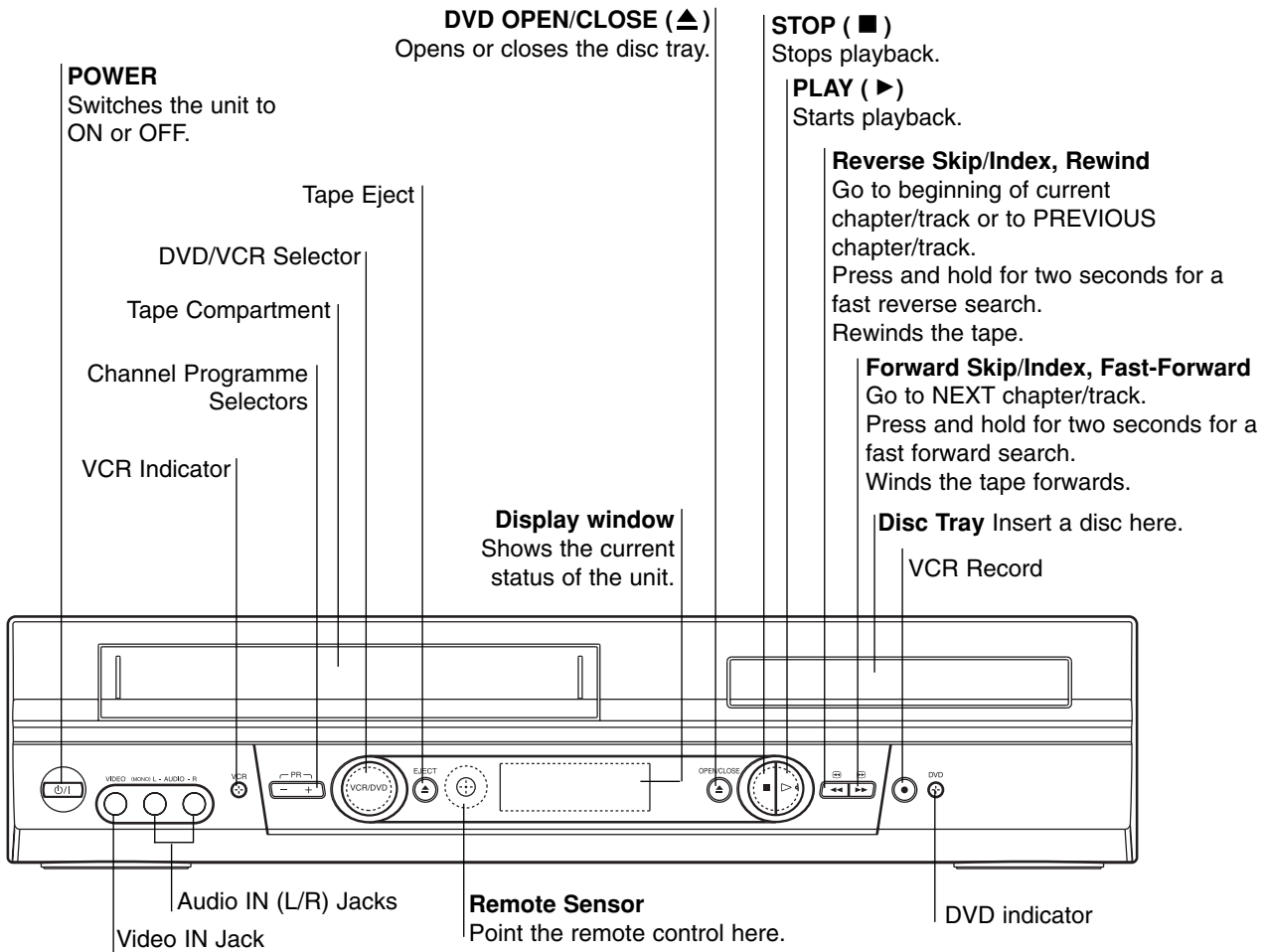

Remote Control

VCR/DVD mode button
Selects operational mode of remote control.

TV or VCR/DVD select switch
- To operate your JVC TV.
- To operate your VCR/DVD.

DISPLAY

- Access the On-Screen Display (DVD).
- Shows you the current time or counter (VCR).

SUBTITLE

Select a subtitle language.

ANGLE

Select DVD camera angle if available

RETURN

- Remove the setup menu.
- Displays the menu of a video CD with PBC.

REPEAT A-B, IIII

- Repeat sequence.
- Select the recording speed of the tape.

ZOOM

Enlarge video image.

TITLE

Display the title menu of the disc if available.

REPEAT

- Repeat chapter, track, title, all.

0-9 numerical buttons

Select numbered items in a menu.

◀ ▶ ▲ ▼ (left/right/up/down)

- Select an item in the menu
- Select channel programme of VCR.
- Select your JVC TV's channel

OK

Acknowledge menu selection.

SETUP/ MENU

Access or remove setup menu.

AUX

Select input source for recording into tape.

AUDIO MONITOR

Select an audio language (DVD) or an audio channel (CD).

PROG.

Access or remove program menu.

RANDOM/

- Play tracks in random order.
- CM SKIP

CANCEL/0000

- Clear a track number on the program menu or a mark on the MARKER SEARCH menu.

- Reset tape counter to zero.

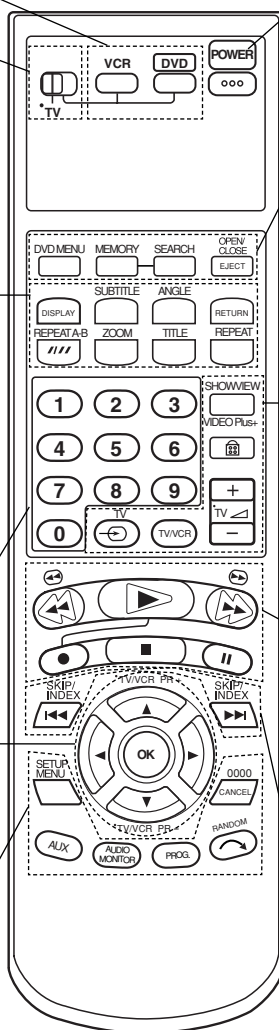

POWER

Switch this unit ON or OFF.

DVD MENU

Access menu of a DVD disc.

MEMORY

Memory any point during playback.

SEARCH

Display MARKER SEARCH menu.

OPEN/CLOSE EJECT

- Open or close the the disc tray.
- Tape Eject.

VIDEO Plus+

To display the programme menu for VIDEO Plus+ programming.

Switch the Child Lock on and off.

TV

Control volume of JVC TV.

TV/VCR

Switch between your TV's tuner and the VCR's internal tuner.

TV

Select your JVC TV's auxiliary input mode

Rewind

Rewinds the tape.

PLAY

Starts playback.

Fast - Forward

Winds the tape forwards.

- Record your input sources into tape.
- Stops playback.

- Pause playback temporarily/press repeatedly for frame-by-frame playback.

Reverse SKIP/INDEX (◀◀)

Search backward* / go to beginning of current chapter or track or go to previous chapter or track.

* Press and hold button for about two seconds.

Forward SKIP/INDEX (▶▶)

Search forward* / go to next chapter or track.

* Press and hold button for about two seconds.

Remote Control Operation Range

Point the remote control at the remote sensor and press the buttons.

- **Distance:** About 23 ft (7 m) from the front of the remote sensor
- **Angle:** About 30° in each direction of the front of the remote sensor

Remote control battery installation

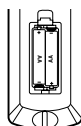

Detach the battery cover on the rear of the remote control, and insert two (size AA) batteries with + and - aligned correctly.

Caution

Do not mix old and new batteries. Never mix different types of batteries (standard, alkaline, etc.).

Remote A/B/C/D Code Switching

The remote control is capable of controlling four JVC video units independently. Each of units can respond to one of four codes (A, B, C or D). The remote control is preset to send A code signals because your unit is initially set to respond to A code signals. You can easily modify your unit to respond to B, C or D code signals.

Before performing the following steps:

Slide the TV/VCR/DVD switch to the right.

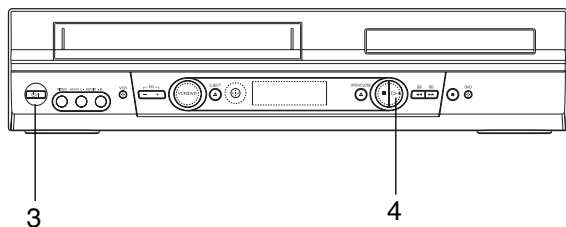
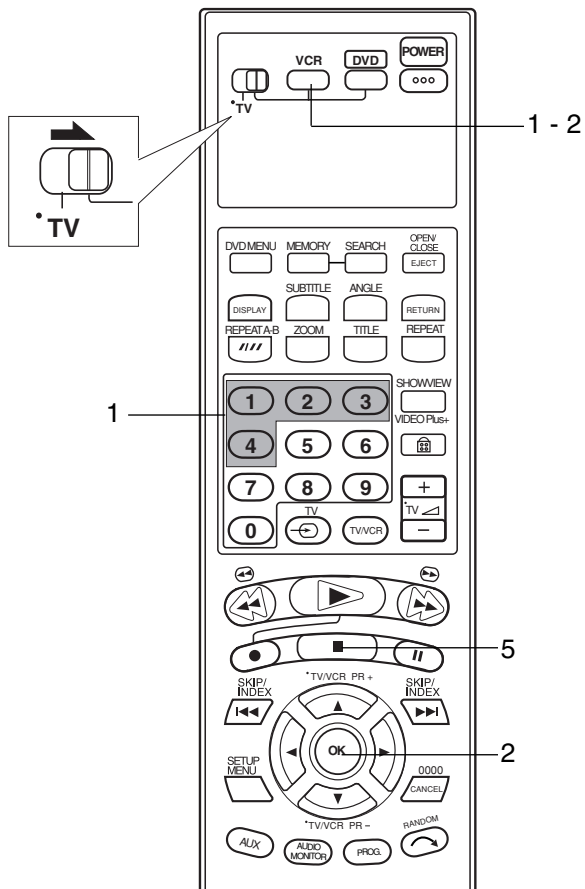

On the remote control

Keep pressing **VCR** down during steps 1 – 2.

1 Change the remote control code.
Press the **number key** “1” for A, “2” for B, “3” for C or “4” for D.

2 Set the remote control code.
Press **OK** to set the code.

On the unit

3 Turn off the unit.
Press **⏻**.

4 Display the code.
Press **PLAY ▷** on the unit for over 5 seconds while the unit is turned off. The code currently set appears on the front display panel.

- If the code displayed on the front display panel is different from the code set on the remote control, go to step 5.

5 Change the unit's code.
Press **■** on the remote control. The code currently set on the remote control will be applied to the unit.

Note

Once you have set the remote control to operate the TV, you do not have to repeat this step until you replace your remote control's batteries or until you pull out the power cord.

TV Multi-Brand Remote Control

Your remote control can operate the basic functions of your TV set. In addition to JVC TVs, other manufacturer's TVs can also be controlled.

Before performing the following steps:

- Turn off the TV using its remote control.
- Slide the **TV/VCR/DVD** switch to the left.

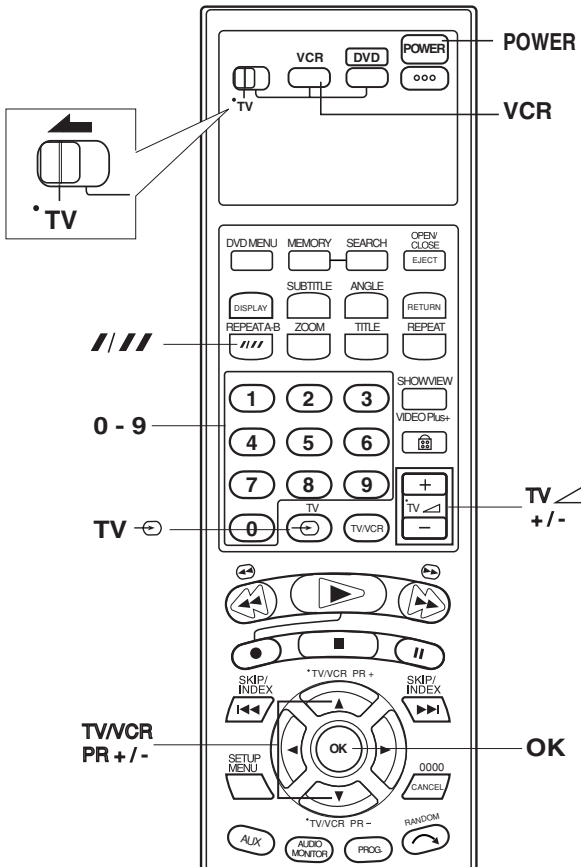

IMPORTANT

Although the provided remote control unit is compatible with JVC televisions, as well as many other models, it may not work with your TV, or in some instances, may have limited function capability.

Control Your TV Using Additional Buttons

Use the **number keys** and the **///** button to select the TV's channel.

- With televisions under Code 01, 02, 07, 10, 11, 14, 20, 23, 24, 25, 27, 33 or 35, the **///** button corresponds to the 1-digit/2-digit entry switching button (often labelled - / -) of your TV's remote control.

Note

The way these buttons are used is determined by your TV. Use these buttons as instructed for your TV's remote control.

1 Set the TV brand code.

Keep pressing **VCR** down during step 1. Enter your TV's brand code using the **number keys**, then press **OK**. Press **POWER** on the unit's remote control to turn on the TV and try operations (-> step 2).

- Once you have set the remote control to operate the TV, you do not have to repeat this step until you replace your remote control's batteries or until you pull out the power cord.
- Some brands of TV have more than one code. If the TV does not function with one code, try entering another.

2 Operate the TV.

Press the corresponding button: **POWER**, **TV** , **TV/VCR PR +/-**, **TV** (Volume), **number keys**.

- For some brands of TV, you must press **OK** after having pressed the **number keys**.

BRAND NAME	CODE
JVC	01, 23, 24, 25
BLAUPUNKT	19
BRANDT	26
FERGUSON	27
FINLUX	30
FUNAI	32
LG/GOLDSTAR	18
GRAETZ	28
GRUNDIG	19
HITACHI	10
ITT	28
LUXOR	28
MITSUBISHI	03
MIVAR	29
NEC	20
NOKIA	31
NORDMENDE	26
PANASONIC	11
PHILIPS	02
SABA	26
SALORA	28
SAMSUNG	02, 12, 33, 34, 35
SELECO	28
SHARP	06
SONY	07
TELEAVIA	26
TELEFUNKEN	26
THOMSON	26
TOSHIBA	14

Rear Panel

AUDIO OUT (Left/Right)(DVD OUT)

Connect to an amplifier, receiver or stereo system.

COMPONENT VIDEO OUT (Y Pb Pr)

Connect to a TV With Y Pb Pr inputs.

DVD/VCR AUDIO OUT (Left/Right)

Connect to an amplifier, receiver or stereo system.

EURO AV2

Connect to Set Top Box or another video recorder.

Video Output Switch

Select either **COMPONENT, S-VIDEO** or **RGB** depending on how you connect this unit to the TV.

AERIAL

Connect the aerial using this jack.

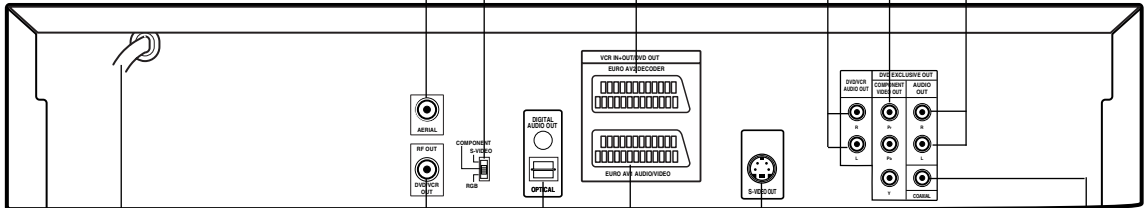

AC Power Cord

Connect to a power source.

RF OUT (DVD/VCR OUT)

Connect to your TV using this jack.

OPTICAL (Digital audio out jack)

Connect to digital (optical) audio equipment.

EURO AV1 AUDIO/VIDEO (VCR IN+OUT/DVD OUT)

Connect to your TV set or another video recorder.

COAXIAL

(Digital audio out jack)
Connect to digital (coaxial) audio equipment.

S-VIDEO OUT (DVD OUT)

Connect to a TV With S-Video input.



Do not touch the inner pins of the jacks on the rear panel. Electrostatic discharge may cause permanent damage to the unit.

Connections

Tips

- Depending on your TV and other equipment you wish to connect, there are various ways you could connect the unit.
- Please refer to the manuals of your TV, Stereo System or other devices as necessary to make the best connections.
- For better sound reproduction, connect this unit's AUDIO OUT jacks to the audio in jacks of your amplifier, receiver, stereo or audio/video equipment. See "Connecting to optional equipment" on page 12.

Caution

- Make sure this unit is connected directly to the TV. Set the TV to the correct video input channel.
- Do not connect this unit's AUDIO OUT jack to the phono in jack (record deck) of your audio system.

Connecting to a TV (Satellite or Set Top Box)

- Make one of the following connections, depending on the capabilities of your existing equipment.
- When using the SCART's RGB signal, set the video output switch to **RGB**. When using the **COMPONENT VIDEO OUT** jacks, set the video output switch to **COMPONENT**. When using the **S-VIDEO OUT** jack, set the video output switch to **S-VIDEO**.

Basic connection (AV)

- 1 Connect the **EURO AV1 AUDIO/VIDEO** on the rear panel of this unit to the SCART input socket on the TV using a SCART lead.
- 2 You can connect such a Satellite or Set Top Box to this unit.

Basic connection (RF)

- 1 Connect the RF antenna cable from your indoor/outdoor antenna to **AERIAL** jack on the rear panel of this unit.
- 2 Connect the supplied RF antenna cable from the **RF OUT (DVD/VCR OUT)** jack on the rear panel of this unit to your television's Antenna Input.

Basic connection (RF)

- 1 Connect the RF antenna cable from your indoor/outdoor antenna to **AERIAL** jack on the rear panel of this unit.
- 2 Connect the supplied RF antenna cable from the **RF OUT (DVD/VCR OUT)** jack on the rear panel of this unit to your television's Antenna Input.

DVD exclusive out connection

• Component Video (Color Stream®) connection

- 1 Connect the **COMPONENT VIDEO OUT** jacks on the DVD Player to the corresponding in jacks on the TV using an Y Pb Pr cable.
- 2 Connect the Left and Right **AUDIO OUT** or **DVD/VCR AUDIO OUT** jacks of the DVD Player to the audio left/right in jacks on the TV using the audio cables.

• S-Video connection

- 1 Connect the **S-VIDEO OUT** jack on this unit to the S-Video input jack on the TV using the S-Video cable.
- 2 Connect the Left and Right **AUDIO OUT** or **DVD/VCR AUDIO OUT** jacks of this unit to the audio left/right in jacks on the TV using the audio cables.

Rear of this unit (Component Video connection)

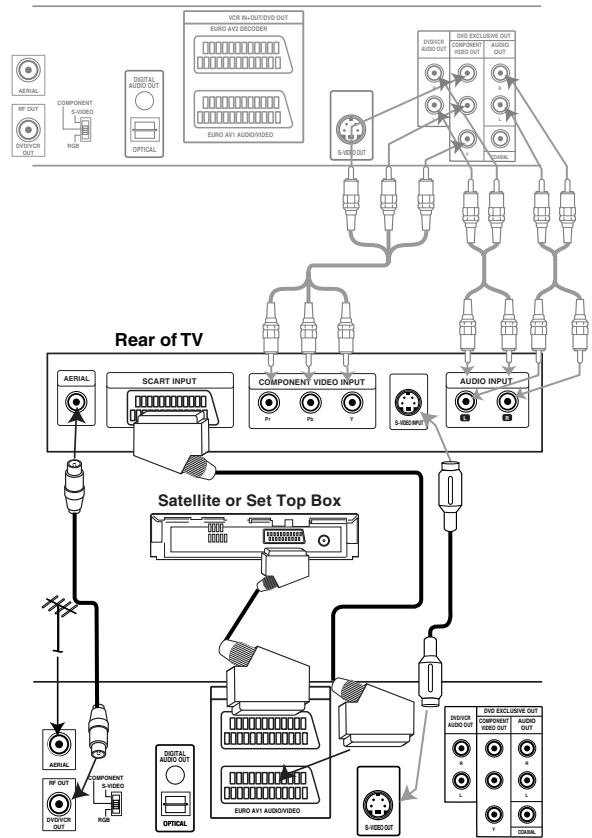

Rear of this unit (Basic connection)

Connecting to Optional Equipment

Connecting to an amplifier equipped with two channel analog stereo or Dolby Surround

Connect the Left and Right Audio out jacks on this unit to the audio left and right in jacks on your amplifier, receiver or stereo system, using the audio cables.

Connecting to an amplifier equipped with two channel digital stereo (PCM) or to an Audio/Video receiver equipped with a multi-channel decoder (Dolby Digital™, MPEG 2 or DTS)

- 1** Connect this unit's DIGITAL AUDIO OUT jack (COAXIAL or OPTICAL) to the corresponding in jack on your amplifier. Use an optional digital (COAXIAL or OPTICAL) audio cable.
- 2** You will need to activate this unit's digital output. (See "Digital Audio Output" on page 20).

Digital Multi-channel sound

A digital multi-channel connection provides the best sound quality. For this you need a multi-channel Audio/Video receiver that supports one or more of the audio formats supported by your unit (MPEG 2, Dolby Digital and DTS). Check the receiver manual and the logos on the front of the receiver.

Warning:

Due to the DTS Licensing agreement, the digital output will be in DTS digital out when DTS audio stream is selected.

Notes

- If the audio format of the digital output does not match the capabilities of your receiver, the receiver will produce a strong, distorted sound or no sound at all.
- To see the audio format of the current DVD in the On-Screen Display, press **AUDIO MONITOR**.

Important notes on controlling this unit

This unit uses one set of controls to operate VCR, DVD and JVC TV. The following buttons are helpful in successfully controlling each part.

* First, select TV or VCR/DVD with the slide switch.

- 1 POWER Button**
Press the POWER button on the remote control or front panel to turn on this unit.
- 2 DVD Button**
Press DVD button on the remote control when you want to control the DVD.
The DVD indicator will light on the front panel display to show that the DVD is selected.
- 3 VCR Button**
Press the VCR button on the remote control when you want to control the VCR.
The VCR indicator will light on the front panel display to show that the VCR is selected.
- 4 VCR/DVD Button**
Press the VCR/DVD button on the front panel to toggle control between the DVD and the VCR.

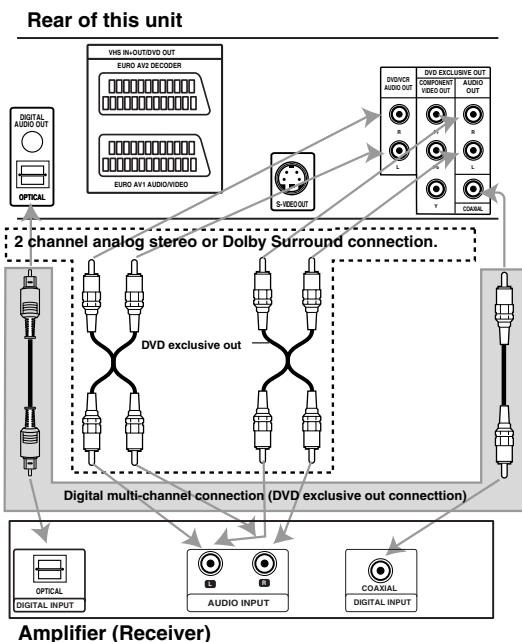

Before Operation - VCR part

Tuning in a video channel on your TV

Notes

- The output frequency of this video recorder (VCR) is set at UHF channel 22. If channel 22 is already used by another TV station, or if the picture is distorted, you can change the transmitter channel of your VCR. Stages 5 ~ 8 will show you how to change the output frequency of your VCR.
- Your TV receives signals from the video recorder (VCR) like another TV station. You have to select a channel number on your TV and tune it in so that you may watch video tapes. If you have used a SCART cable then your TV should already have a dedicated video channel built into it, usually called AV.

1 Make sure that you have correctly installed your VCR as described earlier in this book. Press **POWER** to turn on your VCR. Turn on your TV.

2 Insert a pre-recorded video tape into your VCR and press **PAL Y** on the remote control. Select a TV channel number on which you wish to watch video's. Don't worry if you don't have a video-tape to play at this stage! If you switch your VCR on and continue stages 3 ~ 4, instead of seeing video playback tune your TV until you see a bright blue screen.

3 Tune this channel until the video picture is sharp and the sound is clear. If you have used a SCART cable you will not have to tune your TV, simply select the AV channel. The AV channel is already pre-tuned for optimum video playback on your TV.

4 Store this channel on your TV. You will need to look at the TV instruction book if you do not know how to do this.

5 **Only carry out stages 5 ~ 8 if you cannot obtain clear video playback as described in stages 1 ~ 4.** Select a TV channel number on which you wish to watch video's. Make sure that your VCR is in standby pressing **POWER** on the remote control (only the clock will be displayed).

6 Press **PR -** or **PR +** on the front of your VCR for more than 4 seconds. **RF22** will appear in the display window. The following picture will be displayed on the TV screen.

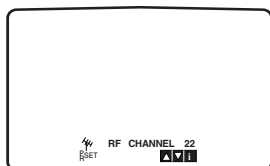

7 Press **PR -** or **PR +** to select another video channel. You may select any channel number between 22 and 68.

You can also set it to "OFF" if there is any interference when your TV is connected to the VCR with a SCART lead.

8 Select a TV channel number on which you wish to watch video's. Press **ON/OFF** on the front of your unit when you have finished. Tune this channel so that a bright blue screen appears. Store this channel on your TV.

Note

Make sure that you have correctly installed your VCR and successfully tuned in a dedicated video channel on your TV. If you do not tune in a dedicated video channel on your TV you will be unable to view and record video tapes!

Initial preset

For the following steps we do assume that you have just connected your video recorder for the very first time. In this case the video recorder is on after mains connection. You should not touch any buttons yet. On the connected TV you will now see initial menu picture screen.

Note - If this menu does not appear, your video recorder was programmed already.

1 If you have a satellite receiver make sure that it is connected to your VCR, switched on and Sky News has been selected.

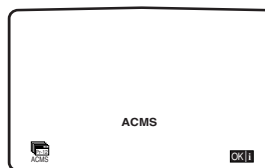

2 Press **OK** to start the automatic storing of the channels of the TV stations in your area.

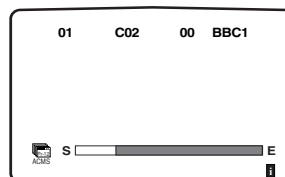

Before Operation - VCR part

Setting the clock Manually

The clock in your VCR controls time and date settings for your VCR.

The clock is set automatically during **ACMS** (Automatic Channel Memory System) when your VCR detects a channel that broadcasts a Teletext signal. If the broadcast signal is weak the clock will not be set and will require setting manually.

- 1 Press **MENU**.
Press ◀ or ▶ to select **TIME DATE**.
Press **OK**.

The auto adjust mode can be set to "OFF" by pressing ▲ or ▼ if you want to set the time manually.
Press **OK**.

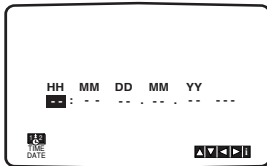
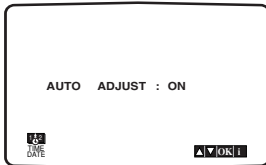

- 2 Use the **numbered buttons** on the remote control to alter the **HOURS, MINUTES, DAY, MONTH** and **YEAR**.

Please note your VCR uses a 24 hour clock. e.g. 1pm will be displayed as 13:00.

The day of the week will appear automatically when you enter the year.

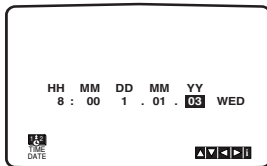

- 3 If you make a mistake press ◀ or ▶ and enter the correct details.

- 4 Press **MENU**.

To set the colour system

- 1 Press **MENU**.
- 2 The main menu will appear on the TV screen.
- 3 Press ◀ or ▶ to select the **SYSTEM** and press **OK**.
- 4 Press ▲ or ▼ to select according to the **COLOUR** system used.

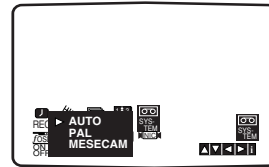

- 5 Press **MENU** to remove the menus from the TV screen.

Before Operation - VCR part

How to use the main menu

This VCR can easily be programmed by using the menus displayed on screen.

The menus are controlled from the Remote Control Handset.

- 1 Switch on your TV set and video recorder by pressing the **POWER** button.
- 2 Press **MENU** button.
The main menu will appear on the TV screen.

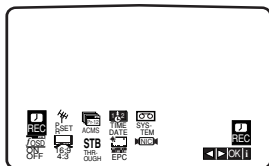

- **REC** - Timer recording setting (see p. 25).
- **PR SET** - Manual tuning setting (see p. 16).
- **ACMS** - ACMS (Automatic Channel Memory System) (see p. 15).
- **TIME DATE** - Date & clock setting (see p. 14).
- **SYSTEM** - To set the Colour TV System (see p. 14).
- **F.OSD ON/OFF** - To display the operational mode of your VCR (see p. 33). Various operational indicators will not appear on the TV screen when this function is set to "OFF".
- **16:9/4:3** - To select the aspect ratio of your TV (see p.34).
- **STB THROUGH** - When Set Top Box is connected to AV2 socket you can watch the channel that you select with STB if you set STB THROUGH to "ON". At this time, you have to set video output switch to "RGB".
- **EPC** - To improve the playback picture (see p. 22).
- **NIC** - To activate or deactivate the NICAM digital sound (see p. 34).

3 Press ◀ and ▶ to select the desired menu.
Press **OK** and press ▲ or ▼ to select.

4 Press "**MENU**" to return to a TV picture.

Tuning in TV Stations Automatically

If the TV broadcast signal is weak your VCR may not detect the necessary information and will be unable to identify station names and sort them correctly. To overcome this problem please turn to the **MANUAL TUNING** section on page 16.

- 1 Press **POWER** to turn on your VCR.
- 2 Press **MENU** button.
The main menu will appear on the TV screen.
Press ◀ or ▶ to select the **ACMS**.
Press **OK**.

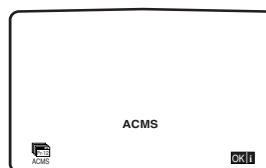
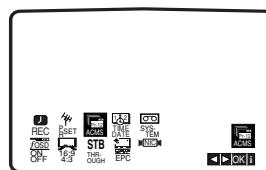

- 3 Press **OK** again to start the automatic tuning process.
The VCR's clock will be set automatically when automatic tuning has finished. If the clock is wrong please see "Setting the clock manually" on page 14.

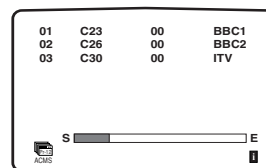

- 4 The **TV STATION TABLE** will appear when tuning is complete.
Press **MENU** to save your settings.

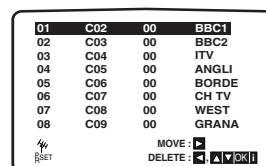

Before Operation - VCR part

Tuning in TV Stations Manually

In certain areas of the country broadcast signals may be too weak for your VCR's automatic tuning process to find or assign TV stations correctly. You must tune in these weaker broadcast stations manually in order for your VCR to store them.

- 1 Press **MENU**.
The main menu will appear on the TV screen. Press **◀** or **▶** to select the **PR SET**. Press **OK**.

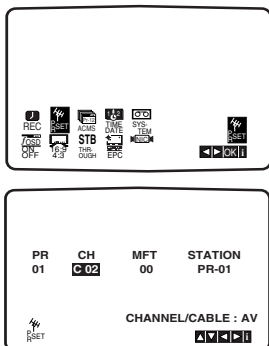

- 2 Press **MENU**.
The station table will appear. Press **▲** or **▼** to select the programme number that you want to tune (for example, PR 09).

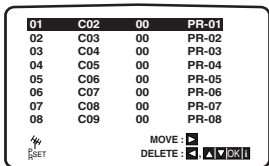

- 3 Press **OK**.
Press **AUX** to select **C** (Standard stations) or **S** (Cable stations):
C02 - C69, S01 - S41.
Enter the channel number of station that you want to tune with **the numbered buttons** or use **▲** or **▼** to find the required station.

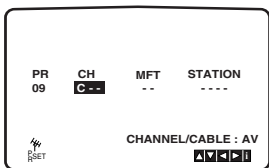

- 4 Searching will stop when it locates a stations.
Press **▶** to select **MFT**.
Press **▲** or **▼** to adjust.

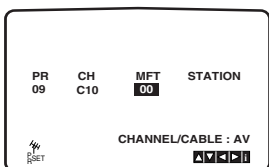

- 5 Press **▶** to select **STATION** so that you may name your TV station.
Press **OK**.
The TV station name list will appear.

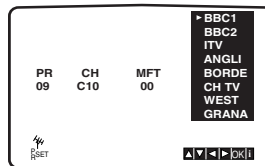

- 6 Press **▲** or **▼** to select a station name from the list.
Press **OK** to select it.

If your station name isn't on the list do not press **OK**, but go to stage 7.

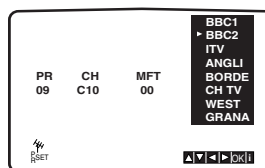

- 7 You can change a TV station name manually rather than using the "standard" names.
Press **▶**.
Press **▲** or **▼** to select **letters** and **numbers** for the new station name.
Press **◀** or **▶** to move back and forth between characters.
Press **OK**.

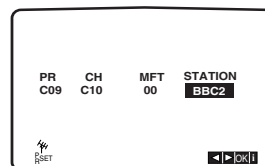

- 8 Press **MENU**, confirm the station placement.
Press **MENU** again.
Your new TV station has now been tuned into your VCR. If you wish to manually tune other stations repeat stages 1 - 8.

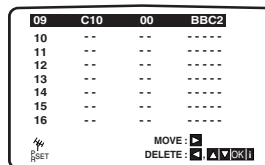

Before Operation - VCR part

Changing the order of TV Stations

After tuning TV stations into your VCR you may wish to change the order in which they are stored without having to retune them. The instructions given on this page will show you how you can simply move them into your desired order.

- 1 Press **MENU**.
The main menu will appear on the TV screen. Press **◀** or **▶** to select the **PR SET**. Press **OK**.

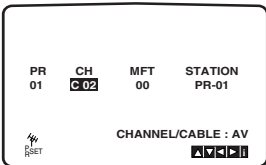
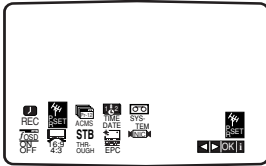

- 2 Press **MENU**.
Press **▲** or **▼** to select the **programme number** you want to move (for example, PR 03). Press **▶**.

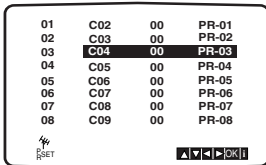
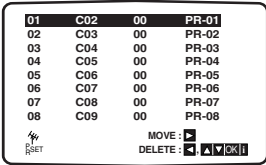

- 3 Press **▲** or **▼** to select the **programme number** you want to move to (for example, PR 05).

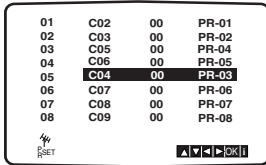

- 4 Press **OK**.
The selected **programme** will be moved to the **new programme number**.
If you wish to move other TV stations repeat stages 1 - 4. Press **MENU** to remove the menus from the TV screen.

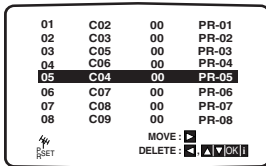

Deleting TV Stations

After tuning TV stations into your VCR you may wish to delete a station. The instructions given on this page will show you how easily delete any unwanted TV stations.

- 1 Press **MENU**.
The main menu will appear on the TV screen. Press **◀** or **▶** to select the **PR SET**. Press **OK**.

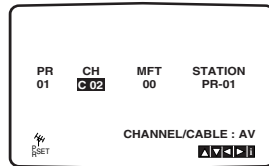
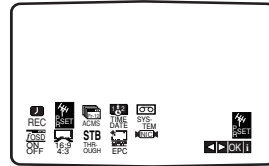

- 2 Press **MENU**.
Press **▲** or **▼** to select the **programme number** you want to delete. (for example, PR 03)

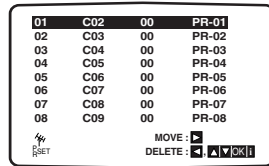

- 3 Press **◀**.
After a short while, the selected station will be deleted.

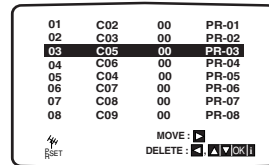

- 4 Press **MENU** to remove the menus from the TV screen.
If you wish to delete other TV stations repeat stages 1 - 3.

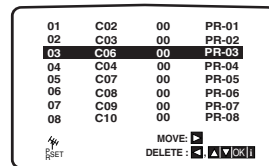

How to select Stored TV stations:

Stored TV stations can be selected in either of two ways. Press **PR -** or **PR +** to select different stations that are tuned into your VCR. You may also directly select stations using the **numbered buttons** on the remote control.

Before Operation - DVD part

General Explanation

This manual gives the basic instructions for operating this unit. Some DVDs require specific operation or allow only limited operation during playback. When this occurs, the symbol  appears on the TV screen, indicating that the operation is not permitted by this unit or is not available on the disc.









On-Screen Display

The general playback status can be displayed on the TV screen. Some items can be changed on the menu.

On-screen display operation

- 1** Press **DISPLAY** during playback.
- 2** Press **▲** or **▼** to select an item.
The selected item will be highlighted.
- 3** Press **◀** or **▶** to change the setting of an item.
The number buttons can be also be used for setting numbers (e.g., title number). For some functions, press **OK** to execute the setting.







Temporary Feedback Field Icons

-  **TITLE** Repeat Title
-  **CHAPT** Repeat Chapter
-  **TRACK** Repeat Track (non-PBC Video CDs only)
-  **ALL** Repeat All Tracks (non-PBC Video CDs only)
-  **A B** Repeat A-B
-  **OFF** Repeat Off
-  Resume play from this point
-  Action prohibited or not available





Notes

- Some discs may not provide all of the below On-Screen Display.
- If no button is pressed for 10 seconds, the On-Screen Display disappears.

DVD

Items		Function (Press ▲/▼ to select desired item)	Selection Method
Title Number	 1/3	Shows the current title number and total number of titles, and skips to the desired title number.	◀ / ▶, or Numbers, OK
Chapter Number	 1/12	Shows the current chapter number and total number of chapters, and skips to the desired chapter number.	◀ / ▶, or Numbers, OK
Time search	 0:16:57	Shows the elapsed playing time, and searches the point by the elapsed time directly.	Numbers, OK
Audio language and Digital Audio Output mode	 1 ENG 5.1 CH	Shows the current audio soundtrack language, encoding method, and channel number, and changes the setting.	◀ / ▶,
Subtitle language	 OFF	Shows the current subtitles language, and changes the setting.	◀ / ▶,
Angle	 1/1	Shows the current angle number and total number of angles, and changes the angle number.	◀ / ▶,
Sound	 NORM.	Shows the current sound mode, and changes the setting.	◀ / ▶

VCD2.0 VCD1.1

Items		Function (Press ▲/▼ to select desired item)	Selection Method
Track Number	 1/4	Shows the current track number, total number of tracks and PBC On mode, and skip to the desired track number.	◀ / ▶, or OK
Time	 0:16:57	Shows the elapsed playing time (Display only)	—
Audio Channel	 STER.	Shows the audio channel, and changes the audio channel.	◀ / ▶
Sound	 NORM.	Shows the current sound mode, and changes the setting.	◀ / ▶

Before Operation (Continued) - DVD part

Initial Settings

You can set your own Personal Preferences on this unit.

Initial Settings General Operation

- 1 Press SETUP.**
The setup menu appears.



- 2 Press ▲/▼ to select the desired item.**
The screen will show the current setting for the selected item, as well as alternate setting(s).
- 3 While the desired item is selected, press ►, then ▲/▼ to select the desired setting.**
- 4 Press OK to confirm your selection.**
Some items require additional steps.
- 5 Press SETUP, RETURN or PLAY ► to exit the setup menu.**

Language

Disc Language **DVD**

Select a language for the disc's Menu, Audio, and Subtitle.

Original : The original language set for the disc is selected.
Other : To select another language, press number buttons to enter the corresponding 4-digit number according to the language code list on page 38. If you enter the wrong language code, press CANCEL.



Menu Language

Select a language for the setup menu. This is the menu you see when you press SETUP.

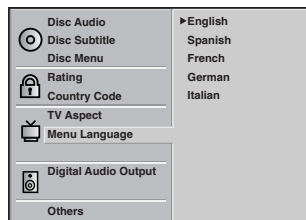

Picture

TV Aspect **DVD**

- 4:3 Letterbox**: Select when a standard 4:3 TV is connected. Displays theatrical images with masking bars above and below the picture.
- 4:3 Panscan**: Select when a standard 4:3 TV is connected. Displays pictures cropped to fill your TV screen. Both sides of the picture are cut off.
- 16:9 Wide**: Select when a 16:9 wide TV is connected.

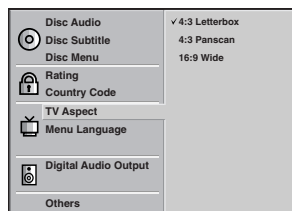

Before Operation (Continued) - DVD part

Sound

Digital Audio Output

Each DVD disc has a variety of audio output options. Set the player's Digital Audio Output according to the type of audio system you use.

DOLBY DIGITAL/PCM: Select "DOLBY DIGITAL/PCM" if you connected this unit's DIGITAL AUDIO OUT (OPTICAL or COAXIAL) jack to a Dolby Digital decoder (or an amplifier or other equipment with a Dolby Digital decoder).

Stream/PCM: Select "Stream/PCM" if you connected this unit's DIGITAL OUT jack to an amplifier or other equipment with a DTS decoder, Dolby Digital decoder or MPEG decoder.

PCM: select when connected to a 2-channel digital stereo amplifier. This unit outputs sounds in the PCM 2ch format when you play a DVD video disc recorded on the Dolby Digital, MPEG1, or MPEG2 recording system.

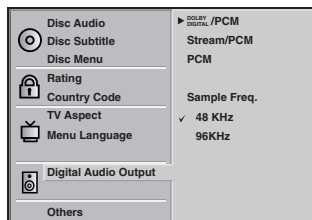

Sample Frequency

To change the Sample Frequency setting, first select the desired Digital Audio Output as indicated as above. If your receiver or amplifier is NOT capable of handling 96KHz signals, select 48KHz. When this choice is made, this unit will automatically convert any 96KHz signals to 48KHz so your system can decode them. If your receiver or amplifier is capable of handling 96KHz signals, select 96KHz. When this choice is made, this unit will pass each type of signal through without any further processing.

Others

The DRC, Vocal and PBC settings can be changed.

- Press ▲/▼ to select the desired item and press OK. The setting of the selected item is changed between On and Off.

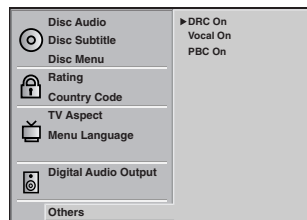

Dynamic Range Control (DRC)

With the DVD format, you can hear a program's soundtrack in the most accurate and realistic presentation possible, thanks to digital audio technology. However, you may wish to compress the dynamic range of the audio output (the difference between the loudest sounds and the quietest ones). Then, you may listen to a movie at a lower volume without losing clarity of sound. Set DRC to On for this effect.

Vocal

Set Vocal to On only when a multi-channel karaoke DVD is playing. The karaoke channels on the disc will mix into a normal stereo sound.

PBC

Set Playback Control (PBC) to On or Off.

On: Video CDs with PBC are played according to the PBC.

Off: Video CDs with PBC are played the same way as Audio CDs.

Parental Control

Rating **DVD**

Movies on DVDs may contain scenes not suitable for children. Therefore, discs may contain Parental Control information that applies to the complete disc or to certain scenes on the disc. These scenes are rated from 1 to 8, and alternatively, more suitable scenes are available for selection on some discs. Ratings are country-dependent. The Parental Control feature allows you to prevent discs from being played by your children or to have certain discs played with alternative scenes.

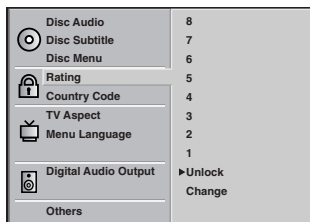

- 1** Select "Rating" on the Setup menu using the ▲ and ▼ buttons.
- 2** While "Rating" is selected, press ►.
- 3** When you have not entered a password yet. Enter a 4-digit password using the numbered buttons to create a personal 4-digit security password, then press OK. Enter the 4-digit password again and press OK to verify.
When you have already entered a password; Enter a 4-digit password using the numbered buttons to confirm the personal 4-digit security password, then press OK.

If you make a mistake before pressing OK, press CANCEL and enter 4-digit security password again.

- 4** Select a rating from 1 to 8 using the ▲/▼ buttons. One (1) has the least playback restrictions. Eight (8) has the most playback restrictions.
Unlock: If you select Unlock, Parental Control is not active. The disc will play in full.
Ratings 1 to 8: Some discs contain scenes not suitable for children. If you set a rating for the player, all disc scenes with the same rating or lower will be played. Higher rated scenes will not be played unless an alternative scene is available on the disc. The alternative must have the same rating or a lower one. If no suitable alternative is found, playback will stop. You must enter the 4-digit password or change the rating level in order to play the disc.

- 5** Press OK to confirm your rating selection, then press SETUP to exit the menu.

Country Code **DVD**

Enter the code of a country/area whose standards were used to rate the DVD video disc, referring to the list (See "Country Code List", page 39).

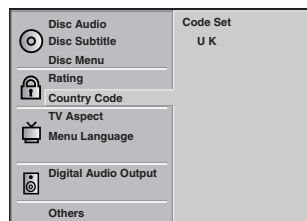

- 1** Select Country Code using the ▲/▼ buttons on the setup menu.
- 2** While Country Code is selected, press ►.
- 3** Follow step 3 of "Rating" on left.
- 4** Select the first character using the ▲/▼ buttons.
- 5** Shift the cursor using ◀▶ buttons and select the second character using ▲/▼ buttons.
- 6** Press OK to confirm your country code selection, then press SETUP to exit the menu.

N Note

Confirmation of the 4-digit password is necessary when the code is changed (see "Changing the 4-digit code" below).

Changing the 4-digit code

- 1 Follow Steps 1-2 as shown above to the left (Rating).
- 2 Enter the old code, then press OK.
- 3 Select Change using the ▲/▼ buttons then press OK.
- 4 Enter the new 4-digit code, then press OK.
- 5 Enter exactly the same code a second time and verify by pressing OK.
- 6 Press SETUP to exit the menu.

If you forget your 4-digit code

If you forget your password, to clear the current password, follow the procedure below.

- 1 Press SETUP to display the setup menu.
- 2 Use the Number buttons to enter the 6-digit number "210499".
The 4-digit password is cleared.
- 3 Enter a new code as shown above to the left (Rating).

Instant Timer Recording (ITR)

Your VCR allows you to make recordings using a variety of simple methods:

Instant Timer Recording (ITR) start recording immediately for a set period of time or until the video cassette runs out.

Your VCR incorporates Long Play (LP) which enables you to record up to twice the amount of time on a video cassette. For example an E-180 will record up to 180 minutes using Standard Play (SP); using LP you will be able to record up to 360 minutes. Please note there will be a slight loss in picture and sound quality when using LP.

- 1** Make sure that you have correctly connected your VCR as described earlier in this book. Press **POWER** to turn on your VCR.
- 2** Insert a video cassette with protection tab into your VCR. The video cassette should have the window side facing up and the arrow facing away from you.
- 3** Press **▲** or **▼** to select the **programme number** you wish to record. You may also directly select programme number using the **numbered buttons** on the remote control.
- 4** If you wish to record directly from the SCART or RCA sockets repeatedly press **AUX** until the socket you wish to record from is displayed.
AV 1 for recording from EURO AV1 SCART socket on the rear of your unit.
AV 2 for recording from EURO AV2 SCART socket on the rear of your unit.
AV 3 for recording from VIDEO IN and AUDIO IN (Left & Right) sockets on the front of your unit.

5 Press **///** if you wish to record in Long Play or Standard Play. SP will produce improved picture and sound quality, however LP will provide twice as much recording time as SP.

6 Press **●** on the front panel or while holding **●**, press **PLAY ►** on the remote control to start recording. **RECORD** will appear on the TV screen. Press **●** on your unit or while holding **●**, press **PLAY ►** on the remote control several times. Each successive press will increase the record time by 30 minutes until you reach a maximum of 9 hours.

7 Press **||** to avoid recording unwanted scenes. Press **||** to continue recording (At this time, the recording mode will be back to normal recording mode.). Tapes can be paused for up to 5 minutes; **RECP** will be displayed when a tape is paused. After 5 minutes your VCR will stop recording to prevent damaging the tape or your VCR.

8 Press **■** twice within 5 seconds to end recording. Press **EJECT**. **EJECT** will appear on the TV screen for a few seconds.

N Notes

- If you do not wish to record on a tape (this can happen quite easily by accident!) remove the protection tab on the back edge of the video cassette.
- It is possible to record on a video cassette with the record protection tab removed by covering the hole with self adhesive tape.
- Remember you can record one programme while watching another by starting your instant recording, pressing **TV/VCR** to appear **TV** indicator in the display window and then selecting a different channel on your TV.

Operation with tape

VIDEO Plus+ recording

VIDEO Plus+ greatly simplifies entering the date, channel, start and end times of a Timer Recording by simply entering a PlusCode. PlusCodes are published in most TV guide magazines; they can vary one to nine numbers in length.

VIDEO Plus+ and PlusCode are registered trademarks of Gemstar Development Corporation. The VIDEO Plus+ system is manufactured under license from Gemstar Development Corporation.

- 1 Make sure that TV channels have been tuned and stored.
Insert a video cassette with protection tab into your VCR.
- 2 Press **VIDEO Plus+**.

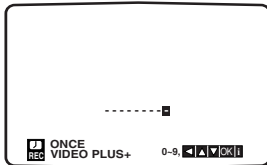

- 3 Press **▲** or **▼** to select the recording type.
ONCE: To record once.
WEEKLY: To record at the same time every week.
DAILY: To record every day (except Saturday and Sunday) at the same time.
- 4 Press the **numbered buttons** to enter the **PlusCode** of the TV programme that you wish to record.

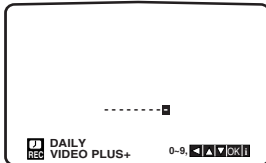

If you make a mistake press **◀** then enter the revised number.

- 5 Press **OK**.
 If **PLEASE CHECK** is displayed it means that you have entered the wrong PlusCode, entered the PlusCode incorrectly.
 If **"-"** is displayed, you have to enter the programme number of the station, you want to record from.

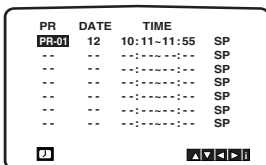

- 6 Press **◀** or **▶** to select the settings that you wish to revise. (PR, DATE, TIME, PDC and SP).
 Press **▲** or **▼** to enter the correct information.

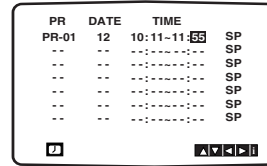

- 7 Press **▶** and press **▲** or **▼** to switch PDC on or off.
 Press **▶** to select the recording speed.
 Press **▲** or **▼** to select the desired tape speed (SP, IP, or LP).
 IP mode determines how much tape is left and switches speed from SP to LP, if necessary, to complete recording the program.
 IP mode is not selected when PDC is ON.
 Check that the timer event details are correct.
 If you wish to record from AUDIO IN and VIDEO IN on the front or from either of the EURO SCART sockets on the back of VCR, press AUX to select for correct display (AV1, AV2 or AV3).

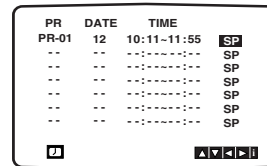

- 8 If you want to make another VIDEO Plus+ recording repeat stages 3 - 7 by pressing VIDEO Plus+ twice.
 Press **MENU** twice to return to TV Picture.
 If **PLEASE CHECK** is displayed, you have entered incorrect information and will need to re-enter the data.
 Press **POWER** to switch your VCR power off mode.
 Ⓞ will appear in the video recorder's display while your VCR waits to make the recording. To watch a DVD during timer recording standby mode, press **POWER** and **VCR/DVD** to switch to DVD mode.

- Note**
 The Programme Delivery Control (**PDC**) system adjusts the start and end times of a timer record event. This can be particularly useful with sports events which may run over into extra time. The PDC signal is transmitted by the broadcaster and this controls your video recorder's timer. Currently only a limited number of TV companies transmit PDC signals.
Please make sure that when recording from channels that do not broadcast PDC that you turn PDC OFF.

Operation with tape

Timer recording using On Screen Display

You may set up to seven timer record events within one month of the current date.

Note

Before setting the timer make sure that you have set the VCR clock correctly and you know which stations you have tuned TV stations on your VCR.

1 Insert a video cassette with protection tab into your VCR.

The video cassette should have the window side facing up and the arrow facing away from you.

2 Press **MENU**.

Press **◀** or **▶** to select **REC**.

Press **OK**.

3 Press **OK** to start setting the timer record event.

If all timer record events are full press **▲** or **▼** to select the event that you wish to remove and replace.

Press **◀** to delete the event.

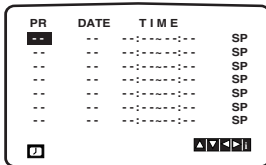

4 Press the **numbered buttons** to enter the station that you wish to record.

When selecting stations 1 - 9, press 0 first, then the channel number; for example Stations 3 - 03. You may also select Channels by pressing **▲** or **▼**.

Once selected press **▶**.

If you wish to record from AUDIO IN (L/R) and VIDEO IN on the front or from the EURO SCART sockets on the back of your unit, press **AUX** to select for correct display (AV1, AV2 or AV3).

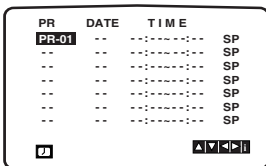

5 Press the **numbered buttons** to enter the date of the programme.

If you press **OK** before entering the date you may select one of the following automated recording features. Press **◀** or **▶** to select, then press **OK** to confirm.

DLY To record every day (except Saturday and Sunday) at the same time.

SU~SA To record at the same time every week.

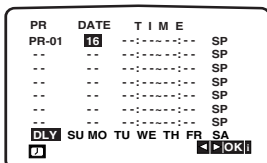

6 Press the **numbered buttons** to enter the recording start and end times of the programme that you wish to record. Please note your VCR uses a 24 hour clock. e.g. 1pm will be displayed as 13:00.

You may also select the the start and end times by pressing **▲** or **▼**.

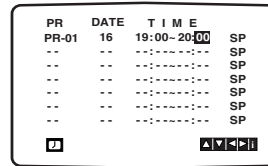

7 Press **▶** and press **▲** or **▼** to switch PDC on or off. Press **▶** to select the recording speed.

Press **▲** or **▼** to select the desired tape speed (SP, IP, or LP). IP mode determines how much tape is left and switches speed from SP to LP, if necessary, to complete recording the program. IP mode is not selected when PDC is ON.

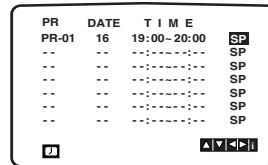

8 Check that the timer event details are correct. Press **MENU** twice.

If **PLEASE CHECK** is displayed, you have entered incorrect and will need to re-enter the data. Press **POWER** to switch your VCR Standby. **TIMER** will appear in the display window while your VCR waits to make the recording.

⊙ will appear in the display window while your VCR waits to make the recording.

To watch a DVD during timer recording standby mode, press **POWER** and **VCR/DVD** to switch to DVD mode.

Notes

- If at a later date you wish to **delete** or **change** any of the settings in timer event memory you may do so without having to enter all the timer event information again. Simply display the timer event screen. Press **▲** or **▼** to select the event that you wish to **delete** or **change**.

Press **◀** to delete the event...or

Press **OK** to change; then press **◀** or **▶** to select; Station, Date, Start and End times and Recording speed. Press **▲** or **▼** to enter the correct information.

- If Timer record events Overlap...**

Make sure that the preset times of the timer recording events do not overlap. If they do, the earlier programme will always be given priority.

Example:

Programme 1 is programmed to start at 16:00 and end at 17:00. Programme 2 is programmed to start at 16:30 and end at 17:30. (In this case, Programme 1 will be recorded in its entirety, but only the last 30 minutes of Programme 2 will be recorded.)

Playing a DVD and Video CD

Playback Setup **DVD** **VCD2.0** **VCD1.1**

- Turn on the TV and select the video input source connected to the DVD with no label player.
- Audio system: Turn on the audio system and select the input source connected to the DVD player.

1 Press **OPEN/CLOSE** to open the disc tray.

2 Load your chosen disc in the tray, with the label facing up.

When a double-sided DVD is inserted, make sure the side you want to play is facing down.

3 Press **OPEN/CLOSE** to close the tray. **READING** appears on the TV screen, and playback starts automatically. If playback does not start, press **PLAY** ▶.

In some cases, the disc menu might appear instead.

If a menu screen is displayed

The menu screen may be displayed first after loading a DVD or Video CD which contains a menu.

DVD

Use the ◀ ▶ ▲ ▼ buttons to select the title/chapter you want to view, then press **OK** to start playback. Press **TITLE** or **DVD MENU** to return to the menu screen.

VCD2.0

- Use the number buttons to select the track you want to view.
Press **RETURN** to return to the menu screen.
- Menu setting and the exact operating procedures for using the menu may differ depending on the disc. Follow the instructions on the each menu screen. You also may set **PBC** to **Off** under setup. See page 20.

Notes

- If Parental Control is set and the disc is not within the Rating settings (not authorized), the 4-digit code must be entered and/or the disc must be authorized (see “Parental Control”, on page 21).
- DVDs may have a region code.
- Your player will not play discs that have a region code different from your player. The region code for this player is 2 (two).
- To watch a DVD during timer recording standby mode, press **POWER** and **VCR/DVD** to switch to DVD mode.

General Features

Note

Unless stated otherwise, all operations described use the remote control. Some features may also be available on the Setup menu.

Moving to another TITLE **DVD** 1/3

When a disc has more than one title, you can move to another title as follows:

- Press **DISPLAY** when playback is stopped, then press the appropriate numbered button (0-9) to select a title number.

Moving to another CHAPTER/TRACK



When a title on a disc has more than one chapter or a disc has more than one track, you can move to another chapter/track as follows:

- Press **SKIP/INDEX** ◀◀ or ▶▶ briefly during playback to select the next chapter/track or to return to the beginning of the current chapter/track.
- Press **SKIP/INDEX** ◀◀ twice briefly to step back to the previous chapter/track.
- To go directly to any chapter during DVD playback, press **DISPLAY**. Then, press ▲/▼ to select **C** (chapter) (or for a Video CD, select **T** for track). Then, enter the chapter/track number using the numbered buttons (0-9).

Note

For two-digit numbers, press the buttons in rapid succession.

Slow Motion **DVD** **VCD2.0** **VCD1.1**

- 1 Press **SKIP/INDEX** ◀◀ or ▶▶ during pause. The player will enter **SLOW** mode.
- 2 Use the **SKIP/INDEX** ◀◀ or ▶▶ to select the required speed: ◀◀ 1/16, ◀◀ 1/8, ◀◀ 1/4 or ◀◀ 1/2 (backward), or ▶▶ 1/16, ▶▶ 1/8, ▶▶ 1/4 or ▶▶ 1/2 (forward).
- 3 To exit slow motion mode, press **PLAY** ▶.

Note

Slow motion playback in reverse is not applicable for Video CD.

General Features (continued)

Still Picture and Frame-by-frame playback

DVD VCD2.0 VCD1.1

- 1 Press **II** during playback.
The player will now go into pause mode.
- 2 You can advance the picture frame-by-frame by pressing **II** repeatedly on the remote control.

Search **DVD VCD2.0 VCD1.1**

- 1 Press and hold **SKIP/INDEX** **I◀◀** or **▶▶I** for about two seconds during playback.
The player will now go into SEARCH mode.
- 2 Press and hold **SKIP/INDEX** **I◀◀** or **▶▶I** repeatedly to select the required speed: **◀◀X2**, **◀◀X4**, **◀◀X16**, **◀◀X100** (backward) or **▶▶X2**, **▶▶X4**, **▶▶X16**, **▶▶X100** (forward).
With a Video CD, the Search speed changes: **◀◀X2**, **◀◀X4**, **◀◀X8** (backward) or **▶▶X2**, **▶▶X4**, **▶▶X8** (forward).
- 3 To exit SEARCH mode, press **PLAY ▶**.

Random **Karaoke DVD VCD1.1**

- 1 Press **RANDOM** during playback or in stop mode.
The unit automatically begins Random Playback and "RANDOM" appears on the TV screen.
- 2 To return to normal playback, press **RANDOM** again until "NORMAL" appears on the TV screen.

Tips

By pressing **SKIP/INDEX** **I◀◀** or **▶▶I** during Random playback, the unit selects another title (track) and resumes Random playback.

Note

This function only works with DVD Karaoke discs and video CD without PBC.

Repeat **DVD VCD2.0 VCD1.1**



DVD Video Discs - Repeat Chapter/Title/Off

- 1 To repeat the currently playing chapter, press **REPEAT**.
The Repeat Chapter icon appears on the TV screen.
- 2 To repeat the title currently playing, press **REPEAT** a second time.
The Repeat Title icon appears on the TV screen.
- 3 To exit Repeat mode, press **REPEAT** a third time.
The Repeat Off icon appears on the TV screen.

Video CDs - Repeat Track/All/Off

- 1 To repeat the track currently playing, press **REPEAT**.
The Repeat Track icon appears on the TV screen.
- 2 To repeat the disc currently playing, press **REPEAT** a second time.
The Repeat All icon appears on the TV screen.
- 3 To exit Repeat mode, press **REPEAT** a third time.
The Repeat Off icon appears on the TV screen.

Note

On a Video CD with PBC, you must set PBC to Off on the setup menu to use the Repeat function. See page 20.

Repeat A-B **DVD VCD2.0 VCD1.1**



To repeat a sequence in a title:

- 1 Press **REPEAT A-B** at your chosen starting point.
A* appears briefly on the TV screen.
- 2 Press **REPEAT A-B** again at your chosen end point.
A B appears briefly on the TV screen, and the repeat sequence begins.
- 3 To cancel the sequence, press **REPEAT A-B**.

Note

If the interval between A and B is too short, you may not be able to set the sequence.

Time Search **DVD**

The Time Search function allows you to start playing at any chosen time on the disc.

- 1 Press **DISPLAY** during playback. The on-screen display appears on the screen.
The Time Search box shows the elapsed playing time of the current disc.
- 2 Within 10 seconds, press **▲/▼** to select the Time Search icon in the on-screen display.
The ":-:--:--" appears in the Time Search box.
- 3 Within 10 seconds, use the number buttons to enter the required start time. Enter hours, minutes, and seconds from left to right in the box.
If you enter the wrong numbers, press **CANCEL** to remove the numbers you entered. Then enter the correct numbers.
- 4 Within 10 seconds, press **OK** to confirm the start time.
Playback starts from the selected time on the disc. If you enter an invalid time, playback will continue from the current point.

3D Surround **DVD VCD2.0 VCD1.1**



This unit can produce a 3D Surround effect, which simulates multi-channel audio playback from two conventional stereo speakers, instead of the five or more speakers normally required to listen to multi-channel audio from a home theater system.

- 1 Press **DISPLAY** during playback.
- 2 Press **▲/▼** to select "NORM." or "3D SUR".
- 3 Press **◀▶** repeatedly until the desired sound is selected.

General Features (continued)

Zoom **DVD** **VCD2.0** **VCD1.1**

The Zoom function allows you to enlarge the video image and to move through the enlarged image.

- 1 Press ZOOM during playback or still playback to activate the Zoom function.
If you press ZOOM repeatedly, the magnification level increases up to six times.
- 2 Use the ◀▶ ▲▼ buttons to move through the zoomed picture.
- 3 Press CANCEL to resume normal playback or return to the paused image.

Note

- The zoom function may not work for some DVDs.
- The zoom function may not work on multi-angle scenes.

Marker Search **DVD** **VCD2.0** **VCD1.1**



You can start playback from a memorized point. Up to nine points can be memorized.

To enter a mark, follow these steps.

- 1 During disc playback, press MEMORY when playback reaches the spot that you want to memorize.
The Marker icon will appear on the TV screen briefly.
- 2 Repeat step 1 to enter up to nine Marker points on a disc.

To Recall a Marked Scene

- 1 During disc playback, press SEARCH.
The MARKER SEARCH menu will appear on the screen.
- 2 Within 10 seconds, press ◀▶ to select a Marker number that you want to recall.
- 3 Press OK.
Playback will start from the Marked scene.
- 4 To remove the MARKER SEARCH menu, press SEARCH.

To clear a Marked Scene

- 1 During disc playback, press SEARCH.
The MARKER SEARCH menu will appear on the screen.
- 2 Press ◀▶ to select the DVD Marker number that you want to erase.
- 3 Press CANCEL.
The Marker number will be erased from the list.
- 4 Repeat steps 2 and 3 to erase additional Marker numbers.
- 5 To remove the MARKER SEARCH menu, press SEARCH.

Special DVD Features **DVD**

Checking the contents of DVD Video discs: Menus

DVDs may contain menus that allow you to access special features. To use the disc menu, press DVD MENU. Then, press the appropriate number button to select an option. Or, use the ◀▶/▲▼ buttons to highlight your selection, then press OK.

Title Menu **DVD**

- 1 Press TITLE.
If the current title has a menu, the menu will appear on the screen. Otherwise, the disc menu may appear.
- 2 The menu can list camera angles, spoken language and subtitle options, and chapters for the title.
- 3 To remove the title menu, press TITLE again.

Disc Menu **DVD**

- 1 Press DVD MENU.
The disc menu is displayed.
- 2 To remove the disc menu, press DVD MENU again.

Camera Angle **DVD**

If the disc contains scenes recorded at different camera angles, you can change to a different camera angle during playback.

- Press ANGLE repeatedly during playback to select a desired angle.
The number of the current angle appears on the display.

Changing the Audio Language **DVD**



Press AUDIO MONITOR repeatedly during playback to hear a different audio language or audio track.

Subtitles **DVD**

Press SUBTITLE repeatedly during playback to see the different subtitle languages.

Note

If  appears, the feature is not available on the disc.

Operation with Audio CD and MP3/WMA Disc

Playing an Audio CD and MP3/WMA Disc

CD **MP3** **WMA**

The DVD Player can play MP3/WMA formatted recordings on CD-ROM, CD-R or CD-RW discs. Before playing MP3/WMA recordings, read the notes on MP3/WMA Recordings on right.

- 1 Insert a disc and close the tray.**
Audio CD; Audio CD menu appears on the TV screen go to step 3.
MP3/WMA disc; The MP3/WMA/JPEG choice menu appears on the TV screen. Go to step 2



- 2 Press ▲/▼ to select the MP3 or WMA then press OK.**

The MP3 or WMA menu appears on the TV screen Press RETURN to move to the MP3/WMA/JPEG choice menu.

- 3 Press ▲/▼ to select a track then press PLAY ► or OK.**

Playback starts. During playback, the current track's elapsed playing time will appear on the display window and menu. Playback will stop at the end of the disc. Press TITLE to move to the next page. Press DVD MENU to move to the previous page.

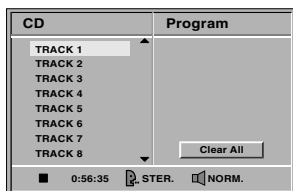

Audio CD menu

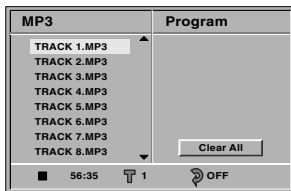

MP3 menu

- 4 To stop playback at any other time, press ■.**

Notes on MP3/WMA Recordings

About MP3

- An MP3 file is audio data compressed by using the MPEG1 audio layer-3 file-coding scheme. We call files that have the “.mp3” file extension “MP3 files”.
- The player can not read an MP3 file that has a file extension other than “.mp3”.

About WMA(Window Media Audio)

- An WMA file is a Microsoft audio compression technology.
- WMA(Windows Media Audio) offers double the audio compression of the MP3 format.

MP3/WMA Disc compatibility with this player is limited as follows:

1. Sampling Frequency / only at 44.1 kHz (MP3), 32-44 kHz (WMA)
2. Bit rate / within 32-320 kbps (MP3), 48-80 kbps (WMA)
3. CD-R physical format should be “ISO 9660”
4. If you record MP3/WMA files using the software which cannot create a FILE SYSTEM, for example “Direct-CD” etc., it is impossible to playback MP3/WMA files. We recommend that you use “Easy-CD Creator”, which creates an ISO9660 file system.
5. A single session disc requires MP3/WMA files in the first track. If there is no MP3/WMA file in the 1st track, it cannot playback MP3/WMA files. If you wish to playback MP3/WMA files, format all the data in the disc or use a new one.
6. File names should be named using 8 letters or less and must incorporate “.mp3” or “.wma” extension e.g. “*****.MP3” or “*****.WMA”.
7. Do not use special letters such as “/ : * ? “ < > ” etc.
8. Total number of files on the disc should be less than 650.

This DVD player requires discs/recordings to meet certain technical standards in order to achieve optimal playback quality. Pre-recorded DVDs are automatically set to these standards. There are many different types of recordable disc formats (including CD-R containing MP3 or WMA files). That require certain pre-existing conditions (see above) to insure compatible playback.

Customers should also note that permission is required in order to download MP3/WMA files and music from the Internet. Our company has no right to grant such permission. Permission should always be sought from the copyright owner.

Operation with Audio and MP3/WMA Disc (Continued)

Pause **CD** **MP3** **WMA**

- 1 Press **II** during playback.
- 2 To return to playback, press **PLAY** **▶** or press **II** again.

Moving to another Track **CD** **MP3** **WMA**

- Press **SKIP/INDEX** **◀◀** or **▶▶** briefly during playback to go to the next track or to return to the beginning of the current track.
- Press **SKIP/INDEX** **◀◀** twice briefly to step back to the previous track.
- In case of audio CD, to go directly to any track, enter the track number using the numbered buttons (0-9) during playback.

Repeat Track/All/Off **CD** **MP3** **WMA**

- 1 To repeat the track currently playing, press **REPEAT**. The Repeat icon and "TRACK" appears on the menu screen.
- 2 To repeat all tracks on a disc, press **REPEAT** a second time. The Repeat icon and "ALL" appears on the menu screen.
- 3 To cancel Repeat mode, press **REPEAT** a third time. The Repeat icon and "OFF" appears on the menu screen.

Search **CD**

- 1 Press and hold **SKIP/INDEX** **◀◀** or **▶▶** for about two seconds during playback. The player will now go into **SEARCH** mode.
- 2 Press and hold **SKIP/INDEX** **◀◀** or **▶▶** repeatedly to select the required speed: **◀◀X2**, **◀◀X4**, **◀◀X8** (backward) or **▶▶X2**, **▶▶X4**, **▶▶X8** (forward). Search speed and direction are indicated on the menu screen.
- 3 To exit **SEARCH** mode, press **PLAY** **▶**.

Random **CD**

- 1 Press **RANDOM** during playback or when playback is stopped. The unit automatically begins Random Playback and "RAND." appears on the menu screen.
- 2 To return to normal playback, press **RANDOM** repeatedly until "RAND." disappears on the menu screen.

Repeat A-B **CD**

To repeat a sequence.

- 1 During disc playback, press **REPEAT A-B** at your chosen starting point. The Repeat icon and "A -" appears on the menu screen.
- 2 Press **REPEAT A-B** again at your chosen end point. The Repeat icon and "A B" appears on the menu screen, and the sequence begins to play repeatedly.
- 3 To exit the sequence and return to normal play, press **REPEAT A-B** again. The Repeat icon and "OFF" appears on the menu screen.

Note

If the interval between A and B is too short, you may not be able to set the sequence.

3D Surround **CD**

This unit can produce a 3D Surround effect, which simulates multi-channel audio playback from two conventional stereo speakers, instead of the five or more speakers normally required to listen to multi-channel audio from a home theater system.

- 1 Press **DISPLAY** or **AUDIO MONITOR** during playback.
- 2 Press **◀▶** to select "NORM." or "3D SUR".
- 3 Press **▲▼** repeatedly until the desired sound is selected.

Changing the Audio Channel **CD**

Press **AUDIO MONITOR** repeatedly during playback to hear a different audio channel (STER., LEFT, or RIGHT).

Viewing a JPEG disc **JPEG**

This DVD Player can play discs with JPEG files. Before playing JPEG recordings, read the notes on JPEG Recordings on right.

- 1 Insert a disc and close the tray.**
The MP3/WMA/JPEG choice menu appears on the TV screen.



- 2 Press ▲/▼ to select the JPEG then press OK.**
The JPEG menu appears on the TV screen.

Press RETURN to move to the MP3/WMA/JPEG choice menu.

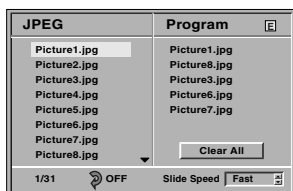

- 3 If you want to view a particular file, press ▲/▼ to highlight a file and press OK or PLAY ►.**

Viewing the file proceeding starts.
During viewing a file, press RETURN to move to the previous menu (JPEG menu).
Press TITLE to move to the next page.
Press DVD MENU to move to the previous page.

- 4 To stop viewing at any other time, press ■.**
The JPEG menu appears.

T Tip

There are three viewing Slide Speed options: Fast, Normal, and Slow. Press ◀/▶ to highlight the Slide Speed then press ▲/▼ to select the option you want to use, and press OK.

Moving to another File

Press SKIP/INDEX ◀◀ or ▶▶ once during viewing a picture to advance to the next file or to the previous file.

Repeat All/Off

- To repeat all files on a disc, press REPEAT when the JPEG menu appears.

The Repeat All icon appears on the menu screen.

- Press PLAY ► or OK to start repeat playback.

- To cancel Repeat mode, first press ■ to stop playback then press REPEAT when the JPEG menu appears.

The Repeat Off icon appears on the menu screen.

Notes on JPEG Recordings

- Depending upon the size and number of the JPEG files, it could take a long time for the DVD player to read the disc's contents. If you don't see an on-screen display after several minutes, some of the files are too big — reduce the resolution of the JPEG files to less than 2 mega pixels and burn another disc.
- Total number of files and folders on the disc should be less than 650.
- Some disc may be incompatible due to different recording format or condition of disc.
- When you are using software such as "Easy CD Creator" to burn the jpeg files into the CD-R, ensure that all the selected files have the ".jpg" extensions when copying into the CD layout.
- If the files have ".jpe" or ".jpeg" extensions, please rename them as ".jpg" files.
- File names without ".jpg" extension will not be able to be read by this DVD player. Even though the files are shown as JPEG image files in windows explorer.

Programmed Playback with Audio CD and MP3/WMA/JPEG Disc

The Program function enables you to store your favorite tracks (or files) from any disc in the player memory.

Program can contain 32 tracks (Audio CD) or 60 tracks (MP3/JPEG/WMA disc).

- 1 Press PROG. during playback (Audio CD, MP3 and WMA only) or in the stop mode to enter the Program Edit mode.**

The  mark will appear to the right of the word "Program" on the right side of the menu screen.

Note

Press PROG. to exit the Program Edit mode; the  mark will disappear.

- 2 Select a track/file, then press OK to place the selected track/file on the Program list.**
- 3 Repeat step 2 to place additional tracks/files on the Program list.**

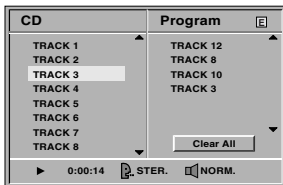

Audio CD menu

- 4 Press ►.**
The programmed track/file you selected last is highlighted on the program list.
- 5 Press ▲/▼ to select the track/file you want to start playing.**
Press TITLE to move to the next page.
Press DVD MENU to move to the previous page.
- 6 Press PLAY ► to start.**
Playback begins in the order in which you programmed the tracks/files.
Playback stops after all of the tracks on the Program list have played once.
- 7 To resume normal playback from programmed playback.**
Press and hold PROG. for 3 seconds until the  mark disappears on the menu screen.

Programmed Playback with Video CD

Note

On a Video CD with PBC, you must set PBC to Off on the setup menu to use the Program function. See page 20.

- 1 Insert Video CD and close the tray.**
- 2 Press PROG. while playback is stopped.**
The VCD Program menu will appear.

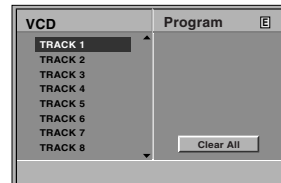

Note

Press RETURN or PROG. to exit the Program menu.

- 3 Follow steps 2-6 of "Programmed Playback with Audio CD and MP3/WMA/JPEG Disc" on left.**
- 4 To return to normal playback, press PROG. again until "NORMAL" appears on the TV screen.**



Repeat Programmed Tracks/ALL/OFF **CD** **MP3** **WMA**

- To repeat the track currently playing, press REPEAT. The Repeat icon and "TRACK" appears on the menu screen.
- To repeat all tracks on the program list, press REPEAT a second time.
The Repeat icon and "ALL" appears on the menu screen.
- To cancel Repeat mode, press REPEAT a third time. The Repeat icon and "OFF" appears on the menu screen.

Repeat Programmed All/Off **JPEG**

- To repeat all files on the program list, press REPEAT when JPEG menu appears.
The Repeat All icon appears on the menu screen.
- Press PLAY ► or OK to start repeat playback.
- To cancel Repeat mode, first press ■ to stop playback then press REPEAT when JPEG menu appears.

Note

The REPEAT button is not available when the  mark appears. Press PROG. to clear the  mark.

Erasing a Track/JPEG from Program List

- Press PROG. during playback (Audio CD and MP3/WMA disc only) or in the stop mode to enter the Program Edit mode.
The  mark will appear.
- Press ► to move to the Program list.
- Use ▲/▼ to select the track/file that you wish to erase from the Program list.
- Press CANCEL.
The track/file will be erased from the Program list.

Erasing the Complete Program List

- Follow steps 1-2 of "Erasing a Track/JPEG from Program List" as above.
- Use ▲/▼ to select "Clear All", then press OK.
The complete Program for the disc will be erased.
The programs are also cleared when the disc is removed.

On Screen Display

You may easily display the current time or tape counter, amount of tape left, day, month, year, day of week, programme channel, tape speed and operational mode of your VCR will appear on the TV screen. If a recording is taking place these On Screen Displays will not be recorded onto the tape.

1 Press **DISPLAY** to display.
Press **DISPLAY** repeatedly to cycle through the display options. The tape counter and amount of tape left will appear if there is a tape loaded.

2 After 3 seconds the majority of the On Screen Displays will clear leaving only the clock or tape counter and the amount of tape left on the screen. Press **DISPLAY** again to remove all displays from the TV screen.

Tape Counter Memory Stop

The **Digital Tape Counter** can be displayed on the display window instead of the time by pressing **DISPLAY** on the remote control. The Digital Tape Counter indicates the relative positions of recordings on the tape.

1 Press **DISPLAY**.
Press **0000** to set the counter to 0:00:00.
Press **PLAY** ► or start recording.
The tape counter will display the actual play time in hours, minutes and seconds.

2 Press ■ when playback or recording is complete.
Press ◀◀.
The tape will rewind and automatically stop when the counter returns to 0:00:00.

Child Lock

The control buttons on the front of the VCR can be switched off so that your VCR can only be operated using the remote control.

1 Press .
SAFE will flicker in the display window for a few seconds.

None of the buttons on the front of your DVD+VCR will work (except ■ and ▲).

If any buttons on the front of your unit are pressed **SAFE** will flicker in the display window for a few seconds.

2 Press  again to switch off the child lock.
OFF will flicker in the display window for a few seconds.

Additional Operation - VCR part

Hi-Fi Stereo Sound System

Your VCR will record and playback Hi-Fi stereo sound. In addition it has a stereo NICAM digital stereo sound decoder. This allows you to record and playback the sound in several different ways. Video cassettes recorded on your VCR will have a normal mono audio track and two VHS Hi-Fi stereo audio tracks. These stereo tracks allow you to make audio recordings in Hi-Fi stereo or bilingual mode from a TV broadcast, stereo audio system, video disc or another Hi-Fi VCR.

- 1 Your VCR's NICAM digital sound decoder allows you to enjoy broadcasts with NICAM sound, as well as standard stereo, bilingual and mono sound. The particular type of sound received or that recorded will be briefly displayed on the TV screen for a couple of seconds:

STEREO NICAM

Sound is automatically recorded on the Hi-Fi stereo and mono tracks of the video tape.

BIL NICAM

Both audio channels will be recorded on the Hi-Fi stereo tracks. The primary language channel (left) will be recorded on the mono track of the video tape.

MONO

The sound is recorded on the Hi-Fi tracks and the mono track of the video tape without any separation.

- 2 Press **AUDIO MONITOR** repeatedly until the desired audio mode appears.

- 3 The choice is **STEREO, LEFT, RIGHT** and **MONO**. In **BIL NICAM** playback the primary language is output on the left channel and the secondary channel is output simultaneously from the right channel when audio output is set to **STEREO**. The primary language will be output from both channels when the audio setting is **MONO**.

Please note that when adjusting the tracking control Hi-Fi stereo sound may revert to **MONO**.

Wide Screen Compatibility 16:9

Your VCR can record and play back wide screen aspect ratio programmes (16:9). To record a wide screen format programme successfully the correct type of wide screen signal must be broadcast by the TV station.

- 1 Switch on your VCR.
Press **MENU**.
Press ◀ or ▶ to select **16:9/4:3**.
Press **OK**.

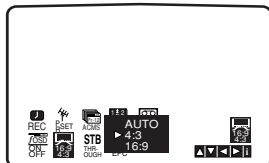
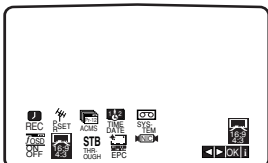

- 2 Press ▲ or ▼ repeatedly to select: **AUTO, 4:3** or **16:9**.

AUTO:

Automatically plays back Wide-Screen programmes as Wide-Screen and Normal programmes as normal.

4:3

Only for playing back and recording Normal format recordings (4:3).

16:9:

Only for playing back and recording Wide-Screen format recordings (16:9).

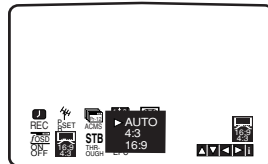

- 3 Press **MENU** to remove the menus from the TV screen.

To enjoy Wide-Screen playback you must connect your VCR to the TV using a SCART cable.

Last Condition Memory

DVD **CD** **VCD1.1**

This player memorizes the last condition for the last disc you have watched. Settings remain in memory even if you remove the disc from the player or switch off the player. If you load a disc that has its settings memorized, the latest stop position is automatically recalled.

Notes

- Settings are stored in memory for use any time.
- This player does not memorize settings of a disc if you switch off the player before commencing to play it.

Screen Saver

The screen saver picture appears when you leave the DVD Player in stop mode for about five minutes.

Video Mode Setting **DVD** **VCD2.0** **VCD1.1**

- With certain discs, the playback picture may be flickering or Dot Crawl is shown on straight lines. That means Vertical interpolation or De-interlace is not perfectly matched with the disc. In this case, the picture quality may be improved by changing the video mode.
- To change the video mode, press and hold DISPLAY about 3 seconds during disc playback. The new video mode number selected is displayed on the TV screen. Check whether the video quality has improved. If not, repeat the above procedure until picture quality is improved.
- Video mode change sequence:
MODE1 → MODE2 → MODE3 → MODE4 →
MODE5 → MODE1
- If you turn off the the power, the video mode will be back to initial state (MODE1).

Copying from DVD To VCR

This unit allows you to copy the contents of a DVD to a VHS.

Note

- If the DVD you are attempting to copy is copy protected, you may not be able to copy the disc. “Lock” will blink on the display window.

1 Insert Disc

Insert the disc you wish to copy in the DVD deck and close the disc tray.

2 Insert VHS Tape

Insert a blank VHS videotape into the VCR deck.

3 Press PLAY ►

The DVD will go into play mode.

- If the DVD disc menu appears, you may need to press the PLAY ► manually to begin copying.

4 Press ● on the front panel or PLAY ► and ● simultaneously on the remote control.

The VCR will go into record mode.

5 Stop the Copy Process.

When the DVD is finished playing, press ■ twice within 5 seconds to end the copy.

- You must stop copy process manually when the DVD movie ends, or the unit may replay and record over and over again.

Recording from another video recorder

With this video recorder you can make recordings from an external source, such as copying from another video recorder or a camcorder.

Note

In the following description, this video recorder will be one used for recording and will be referred to as VCR B. The other appliance will be used for playback and will be referred to as VCR A.

1 VCR A should be connected to the SCART socket on the rear panel of your unit or the AV sockets on the front panel of your unit.

2 Insert the recorded tape into VCR A and a blank tape into VCR B.

3 To start recording, press the ● on VCR B and PALY ► on VCR A.

4 When you want to finish copying, press the ■ on both video recorders.
Press ■ twice within 5 seconds at this unit.

Troubleshooting

Check the following guide for the possible cause of a problem before contacting service.

Symptom	Cause	Correction
DVD or VCR do not work properly.	<ul style="list-style-type: none"> DVD or VCR button is not switched properly. 	<ul style="list-style-type: none"> Refer to page 2.
No power.	<ul style="list-style-type: none"> The power cord is disconnected. 	<ul style="list-style-type: none"> Plug the power cord into the wall outlet securely.
The power is on, but the DVD player does not work.	<ul style="list-style-type: none"> No disc is inserted. 	<ul style="list-style-type: none"> Insert a disc. (Check that the DVD or, audio CD indicator in the display window is lit.)
No picture.	<ul style="list-style-type: none"> The TV is not set to receive DVD signal output. 	<ul style="list-style-type: none"> Select the appropriate video input mode on the TV so the picture from the DVD player appears on the TV screen.
	<ul style="list-style-type: none"> The video cable is not connected securely. 	<ul style="list-style-type: none"> Connect the video cable into the jacks securely.
No sound.	<ul style="list-style-type: none"> The equipment connected with the audio cable is not set to receive DVD signal output. 	<ul style="list-style-type: none"> Select the correct input mode of the audio receiver so you can listen to the sound from the DVD player.
	<ul style="list-style-type: none"> The audio cables are not connected securely. 	<ul style="list-style-type: none"> Connect the audio cable into the jacks securely.
	<ul style="list-style-type: none"> The power of the equipment connected with the audio cable is turned off. 	<ul style="list-style-type: none"> Turn on the equipment connected with the audio cable.
	<ul style="list-style-type: none"> The Digital Audio Output is set to the wrong position. 	<ul style="list-style-type: none"> Set the Digital Audio Output to the correct position, then turn on the DVD player again by pressing POWER.
The picture is poor.	<ul style="list-style-type: none"> The disc is dirty. The TV channels are not tuned in properly. 	<ul style="list-style-type: none"> Clean the disc. Check tuning, carry out tuning again.
The DVD player does not start playback.	<ul style="list-style-type: none"> An unplayable disc is inserted. 	<ul style="list-style-type: none"> Insert a playable disc. (Check the disc type and Regional code.)
	<ul style="list-style-type: none"> The disc is placed upside down. 	<ul style="list-style-type: none"> Place the disc with the playback side down.
	<ul style="list-style-type: none"> The disc is not placed within the guide. 	<ul style="list-style-type: none"> Place the disc on the disc tray correctly inside the guide.
	<ul style="list-style-type: none"> The disc is dirty. 	<ul style="list-style-type: none"> Clean the disc.
	<ul style="list-style-type: none"> The Rating level is set. 	<ul style="list-style-type: none"> Cancel the Rating function or change the rating level.
The remote control does not work properly.	<ul style="list-style-type: none"> There is an obstacle in the path of the remote control and this unit. 	<ul style="list-style-type: none"> Remove the obstacle.
	<ul style="list-style-type: none"> The batteries in the remote control are exhausted. 	<ul style="list-style-type: none"> Replace the batteries with new ones.
Video tape cannot be inserted.	<ul style="list-style-type: none"> Is the cassette compartment empty? 	<ul style="list-style-type: none"> Eject the tape in.
No Hi-Fi sound	<ul style="list-style-type: none"> Audio mode is not set properly. 	<ul style="list-style-type: none"> Select "STEREO" by repeatedly pressing "AUDIO MONITOR" on the remote control.

Video Head Cleaning

Dirt accumulating on the head after a long period of time can cause the playback picture to become blurred or broken up. High quality video cassette tapes will not normally deposit dirt onto the video head, but old or damaged tapes might. Clean the video heads with a commercially available video heads cleaning tape.

Language Code List

Enter the appropriate code number for the initial settings “Disc Audio”, “Disc Subtitle” and/or “Disc Menu” (See page 19).

Code	Language	Code	Language	Code	Language	Code	Language
6566	Abkhazian	7074	Fiji	7678	Lingala	8373	Singhalese
6565	Afar	7073	Finnish	7684	Lithuanian	8375	Slovak
6570	Afrikaans	7082	French	7775	Macedonian	8376	Slovenian
8381	Albanian	7089	Frisian	7771	Malagasy	8379	Somali
6577	Ameharic	7176	Galician	7783	Malay	6983	Spanish
6582	Arabic	7565	Georgian	7776	Malayalam	8385	Sudanese
7289	Armenian	6869	German	7784	Maltese	8387	Swahili
6583	Assamese	6976	Greek	7773	Maori	8386	Swedish
6588	Aymara	7576	Greenlandic	7782	Marathi	8476	Tagalog
6590	Azerbaijani	7178	Guarani	7779	Moldavian	8471	Tajik
6665	Bashkir	7185	Gujarati	7778	Mongolian	8465	Tamil
6985	Basque	7265	Hausa	7865	Nauru	8484	Tatar
6678	Bengali; Bangla	7387	Hebrew	7869	Nepali	8469	Telugu
6890	Bhutani	7273	Hindi	7879	Norwegian	8472	Thai
6672	Bihari	7285	Hungarian	7982	Oriya	6679	Tibetan
6682	Breton	7383	Icelandic	8065	Panjabi	8473	Tigrinya
6671	Bulgarian	7378	Indonesian	8083	Pashto, Pushto	8479	Tonga
7789	Burmese	7365	Interlingua	7065	Persian	8482	Turkish
6669	Byelorussian	7165	Irish	8076	Polish	8475	Turkmen
7577	Cambodian	7384	Italian	8084	Portuguese	8487	Twi
6765	Catalan	7465	Japanese	8185	Quechua	8575	Ukrainian
9072	Chinese	7487	Javanese	8277	Rhaeto-Romance	8582	Urdu
6779	Corsican	7578	Kannada	8279	Rumanian	8590	Uzbek
7282	Croatian	7583	Kashmiri	8285	Russian	8673	Vietnamese
6783	Czech	7575	Kazakh	8377	Samoan	8679	Volapük
6865	Danish	7589	Kirghiz	8365	Sanskrit	6789	Welsh
7876	Dutch	7579	Korean	7168	Scots Gaelic	8779	Wolof
6978	English	7585	Kurdish	8382	Serbian	8872	Xhosa
6979	Esperanto	7679	Laothian	8372	Serbo-Croatian	7473	Yiddish
6984	Estonian	7665	Latin	8378	Shona	8979	Yoruba
7079	Faroese	7686	Latvian, Lettish	8368	Sindhi	9085	Zulu

Country Code List

Enter the appropriate code number for the initial setting "Country Code" (See page 21).

Code	Country	Code	Country	Code	Country	Code	Country
AD	Andorra	ER	Eritrea	LC	Saint Lucia	SC	Seychelles
AE	United Arab Emirates	ES	Spain	LI	Liechtenstein	SD	Sudan
AF	Afghanistan	ET	Ethiopia	LK	Sri Lanka	SE	Sweden
AG	Antigua and Barbuda	FI	Finland	LR	Liberia	SG	Singapore
AI	Anguilla	FJ	Fiji	LS	Lesotho	SH	Saint Helena
AL	Albania	FK	Falkland Islands	LT	Lithuania	SI	Slovenia
AM	Armenia	FM	Micronesia	LU	Luxembourg	SJ	Svalbard and Jan Mayen Islands
AN	Netherlands Antilles	FO	Faroe Islands	LV	Latvia	SK	Slovak Republic
AO	Angola	FR	France	LY	Libya	SL	Sierra Leone
AQ	Antarctica	FX	France (European Territory)	MA	Morocco	SM	San Marino
AR	Argentina	GA	Gabon	MC	Monaco	SN	Senegal
AS	American Samoa	GB	Great Britain	MD	Moldavia	SO	Somalia
AT	Austria	GD	Grenada	MG	Madagascar	SR	Suriname
AU	Australia	GE	Georgia	MH	Marshall Islands	ST	Saint Tome and Principe
AW	Aruba	GF	French Guyana	MK	Macedonia	SU	Former USSR
AZ	Azerbaijan	GH	Ghana	ML	Mali	SV	El Salvador
BA	Bosnia-Herzegovina	GI	Gibraltar	MM	Myanmar	SY	Syria
BB	Barbados	GL	Greenland	MN	Mongolia	SZ	Swaziland
BD	Bangladesh	GM	Gambia	MO	Macau	TC	Turks and Caicos Islands
BE	Belgium	GN	Guinea	MP	Northern Mariana Islands	TD	Chad
BF	Burkina Faso	GP	Guadeloupe (French)	MQ	Martinique (French)	TF	French Southern Territories
BG	Bulgaria	GQ	Equatorial Guinea	MR	Mauritania	TG	Togo
BH	Bahrain	GR	Greece	MS	Montserrat	TH	Thailand
BI	Burundi	GS	S. Georgia & S. Sandwich Isls.	MT	Malta	TJ	Tadjikistan
BJ	Benin	GT	Guatemala	MU	Mauritius	TK	Tokelau
BM	Bermuda	GU	Guam (USA)	MV	Maldives	TM	Turkmenistan
BN	Brunei Darussalam	GW	Guinea Bissau	MW	Malawi	TN	Tunisia
BO	Bolivia	GY	Guyana	MX	Mexico	TO	Tonga
BR	Brazil	HK	Hong Kong	MY	Malaysia	TP	East Timor
BS	Bahamas	HM	Heard and McDonald Islands	MZ	Mozambique	TR	Turkey
BT	Bhutan	HN	Honduras	NA	Namibia	TT	Trinidad and Tobago
BV	Bouvet Island	HR	Croatia	NC	New Caledonia (French)	TV	Tuvalu
BW	Botswana	HT	Haiti	NE	Niger	TW	Taiwan
BY	Belarus	HU	Hungary	NF	Norfolk Island	TZ	Tanzania
BZ	Belize	ID	Indonesia	NG	Nigeria	UA	Ukraine
CA	Canada	IE	Ireland	NI	Nicaragua	UG	Uganda
CC	Cocos (Keeling) Islands	IN	India	NL	Netherlands	UK	United Kingdom
CF	Central African Republic	IO	British Indian Ocean Territory	NO	Norway	UM	USA Minor Outlying Islands
CG	Congo	IQ	Iraq	NP	Nepal	US	United States
CH	Switzerland	IR	Iran	NR	Nauru	UY	Uruguay
CI	Ivory Coast	IS	Iceland	NU	Niue	UZ	Uzbekistan
CK	Cook Islands	IT	Italy	NZ	New Zealand	VA	Vatican City State
CL	Chile	JM	Jamaica	OM	Oman	VC	Saint Vincent & Grenadines
CM	Cameroon	JO	Jordan	PA	Panama	VE	Venezuela
CN	China	JP	Japan	PE	Peru	VG	Virgin Islands (British)
CO	Colombia	KE	Kenya	PF	Polynesia (French)	VI	Virgin Islands (USA)
CR	Costa Rica	KG	Kyrgyzstan	PG	Papua New Guinea	VN	Vietnam
CS	Former Czechoslovakia	KH	Cambodia	PH	Philippines	VU	Vanuatu
CU	Cuba	KI	Kiribati	PK	Pakistan	WF	Wallis and Futuna Islands
CV	Cape Verde	KM	Comoros	PL	Poland	WS	Samoa
CX	Christmas Island	KN	Saint Kitts & Nevis Anguilla	PN	Pitcairn Island	YE	Yemen
CY	Cyprus	KP	North Korea	PR	Puerto Rico	YT	Mayotte
CZ	Czech Republic	KR	South Korea	PT	Portugal	YU	Yugoslavia
DE	Germany	KW	Kuwait	PW	Palau	ZA	South Africa
DJ	Djibouti	KY	Cayman Islands	PY	Paraguay	ZM	Zambia
DK	Denmark	KZ	Kazakhstan	QA	Qatar	ZR	Zaire
DM	Dominica	LA	Laos	RE	Reunion (French)	ZW	Zimbabwe
DO	Dominican Republic	LB	Lebanon	RO	Romania		
DZ	Algeria			RU	Russian Federation		
EC	Ecuador			RW	Rwanda		
EE	Estonia			SA	Saudi Arabia		
EG	Egypt			SB	Solomon Islands		
EH	Western Sahara						

Specification

General

Power requirements	AC 200-240V, 50/60 Hz
Power consumption	Operation mode : 23W Standby mode : 6.7W
Dimensions (approx.)	430 X 97.5 X 293 mm (w/h/d)
Mass (approx.)	4.8 kg
Operating temperature	5°C to 35°C (41°F to 95°F)
Operating humidity	5 % to 90 %
Timer	24 hours display tape
Program capacity	1 month 7 program
RF Modulator	UHF 22-68 (Adjustable)

System

Laser	Semiconductor laser, wavelength 650 nm
Video Head system	Double azimuth 4 heads, helical scanning.
Signal system	PAL
Frequency response	DVD (PCM 96 kHz): 8 Hz to 44 kHz DVD (PCM 48 kHz): 8 Hz to 22 kHz CD: 8 Hz to 20 kHz
Signal-to-noise ratio	More than 100dB (ANALOG OUT connectors only)
Harmonic distortion	Less than 0.008%
Dynamic range	More than 100 dB (DVD) More than 95 dB (CD)

Inputs (VCR)

Audio	-6.0dBm, more than 10 kohms (SCART) -6.0dBm, more than 47 kohms (RCA)
Video	1.0 Vp-p, 75 ohms, unbalanced (SCART/RCA)

Outputs (DVD)

S-VIDEO OUT	(Y) 1.0 Vp-p 75 ohms, negative sync., Mini Din 4-pin x 1 (C) 0.3 Vp-p 75 ohms
COMPONENT VIDEO OUT	(Y) 1.0 V (p-p), 75 Ω, negative sync, RCA jack x 1 (Pb)/(Pr) 0.7 V (p-p), 75 Ω, RCA jack x 2
Audio output (digital audio)	0.5 V (p-p), 75 Ω, RCA jack x 1
Audio output (optical audio)	5 V (p-p), 75 Ω, Optical connector x 1
Audio output (analog audio)	2.0 Vrms (1 kHz, 0 dB), 330 Ω, RCA jack (L, R) x 2/SCART(TO TV)

Outputs (VCR)

Audio	-6.0dBm, less than 1 kohms (SCART)
Video	1.0Vp-p, 75 ohms, unbalanced (SCART)

- Design and specifications are subject to change without notice.

Manufactured under license from Dolby Laboratories. "Dolby" and double-D symbol are trademarks of Dolby Laboratories. Confidential Unpublished Works. © 1992-1997 Dolby Laboratories, Inc. All rights reserved.

Manufactured under license from Digital Theater Systems, Inc. US Pat. No. 5,451,942 and other world-wide patents issued and pending. "DTS" and "DTS Digital Out" are trademarks of Digital Theater Systems, Inc. Copyright 1996 Digital Theater Systems, Inc. All rights reserved.

